



Características técnicas



RAL 9016
estándar



Otros colores
bajo pedido



Acero
inoxidable



Rango

Hasta 4,2 m



Tipos de calefacción

E : eléctrica 3 etapas

P : agua

A : sin calefacción

DX : bomba calor [*]



Bastidor [**]

Acero galvanizado



Caudal / Longitud

1860 - 7200 m³/h
1 m a 3 m



Potencia calorífica

E : 3 - 30 kW

P : 9,2 - 40,3 kW



Tipo de reja

Perforada rectangular



Ventiladores

Centrífugos
5 velocidades



Control

Regulador manual Plug&Play

+ control remoto IR

(Control Clever opcional)



Lamas de descarga

Aluminio, tipo airfoil

Ajustable 0-15° cada lado

[*] Consultar catálogo DX

[**] Bajo pedido, medidas personalizadas

La cortina de aire INVISAIR está diseñada para instalarse de forma invisible en falsos techos, columnas o cajones alrededor de la puerta. Es una solución ideal para aquellas entradas que por razones arquitectónicas requieren una instalación de cortina de aire totalmente integrada en el diseño interior del edificio. Puede instalarse de forma vertical u horizontal.

El flujo de aire en el modelo Invisair sigue una línea recta desde la reja de aspiración hasta la descarga. La aspiración dentro de un tabique o columna debe diseñarse con una reja adecuada suministrada por terceros.

Este modelo de cortina de aire funciona con ventiladores centrífugos de doble aspiración con motores de rotor externo de bajo nivel sonoro. Los modelos "EC" incorporan ventiladores eficientes de muy bajo consumo.

Incluye control Plug&Play con cable RJ45 de 7m y mando a distancia por infrarrojos. Opcionalmente se puede regular con el control avanzado Clever (programable, automático, inteligente, compatible con Modbus RTU para BMS).

❄ SIN CALEFACCIÓN

Modelo	Caudal	Potencia ventilación 230V~50Hz	Intensidad ventilación 230V~50Hz	Nivel sonoro (5 m)	Peso
	m ³ /h	kW	A	dB(A)	kg
IM 1000 A	1980	0,318	1,41	55	48
IM 1500 A	2640	0,424	1,88	56	55
IM 2000 A	3960	0,636	2,82	57	68
IM 2500 A	4620	0,742	3,29	58	73
IM 3000 A	5280	0,848	3,76	59	84
IG 1000 A	2400	0,642	2,85	57	53
IG 1500 A	3200	0,856	3,80	58	60
IG 2000 A	4800	1,284	5,70	59	78
IG 2500 A	5600	1,498	6,65	60	83
IG 3000 A	6400	1,712	7,60	61	94
IECG 1000 A	2700	0,213	1,86	61	53
IECG 1500 A	3600	0,284	2,48	62	60
IECG 2000 A	5400	0,426	3,72	63	78
IECG 2500 A	6300	0,497	4,34	64	83
IECG 3000 A	7200	0,568	5,96	65	94



⚡ CALEFACCIÓN ELÉCTRICA

Modelo	Caudal	Potencia calorífica eléctrica 400Vx3~50Hz (*)	Potencia ventilación 230V~50Hz	Intensidad ventilación 230V~50Hz	Nivel sonoro (5 m)	Peso
	m³/h	kW	kW	A	dB(A)	
IM 1000 E	1980	3/6/9	0,318	1,41	55	58
IM 1500 E	2640	4/8/12	0,424	1,88	56	67
IM 2000 E	3960	6/12/18	0,636	2,82	57	86
IM 2500 E	4620	6/12/18	0,742	3,29	58	93
IM 3000 E	5280	8/16/24	0,848	3,76	59	108
IG 1000 E	2400	5/10/15	0,642	2,85	57	64
IG 1500 E	3200	7,5/15/22,5	0,856	3,80	58	73
IG 2000 E	4800	10/20/30	1,284	5,70	59	96
IG 2500 E	5600	10/20/30	1,498	6,65	60	103
IG 3000 E	6400	10/20/30	1,712	7,60	61	118
IECG 1000 E	2700	5/10/15	0,213	1,86	61	64
IECG 1500 E	3600	7,5/15/22,5	0,284	2,48	62	73
IECG 2000 E	5400	10/20/30	0,426	3,72	63	96
IECG 2500 E	6300	10/20/30	0,497	4,34	64	103
IECG 3000 E	7200	10/20/30	0,568	5,96	65	118

(*) Bajo pedido, se pueden suministrar baterías eléctricas en otras potencias.

💧 CALEFACCIÓN AGUA

Modelo	Caudal m³/h	P86 (80/60°C)		P64 (60/40°C)		P54 (50/40°C)		Potencia ventilación 230V~50Hz kW	Intensidad ventilación 230V~50Hz A	Nivel sonoro (5 m) dB(A)	Peso kg
		Potencia calorífica kW	Pérdida presión agua Pa	Potencia calorífica kW	Pérdida presión agua Pa	Potencia calorífica kW	Pérdida presión agua Pa				
IM 1000 P	1860	9,84	1000	9,22	4990	-	-	0,318	1,41	55	55
IM 1500 P	2480	14,23	760	13,65	6430	-	-	0,424	1,88	56	63
IM 2000 P	3720	22,17	2190	19,70	5470	-	-	0,636	2,82	57	78
IM 2500 P	4340	27,69	4000	23,48	4060	-	-	0,742	3,29	58	86
IM 3000 P	4960	33,15	6560	28,29	6730	-	-	0,848	3,76	59	100
IG 1000 P	2250	11,04	1230	10,42	6190	10,56	1790	0,642	2,85	57	60
IG 1500 P	3000	16,02	940	15,47	8020	16,37	5670	0,856	3,80	58	68
IG 2000 P	4500	24,92	2700	22,29	6810	23,15	3030	1,284	5,70	59	89
IG 2500 P	5250	31,16	4930	26,61	5060	28,76	5450	1,498	6,65	60	94
IG 3000 P	6000	37,35	8110	32,10	8410	34,03	7180	1,712	7,60	61	108
IECG 1000 P	2550	11,89	1400	11,27	7110	11,50	2090	0,213	1,86	54	61
IECG 1500 P	3400	17,29	1070	16,77	9240	17,86	6620	0,284	2,48	62	69
IECG 2000 P	5100	26,86	3080	24,14	7850	25,24	3530	0,426	3,72	63	89
IECG 2500 P	5950	33,63	5650	28,84	5840	31,38	6360	0,497	4,34	64	94
IECG 3000 P	6800	40,34	9290	34,81	9710	37,16	8400	0,568	5,96	65	108

Baterías de agua: las conexiones P86 y P64 son 2x3/4" hembra (macho si conexiones laterales), P54 2x1" macho.
P86 2 filas. P64 3 filas. P54 4 filas.



Selection program



Dimensiones

Instalación horizontal

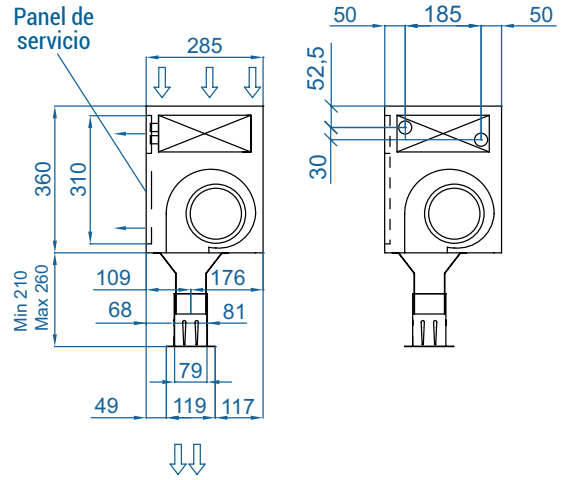
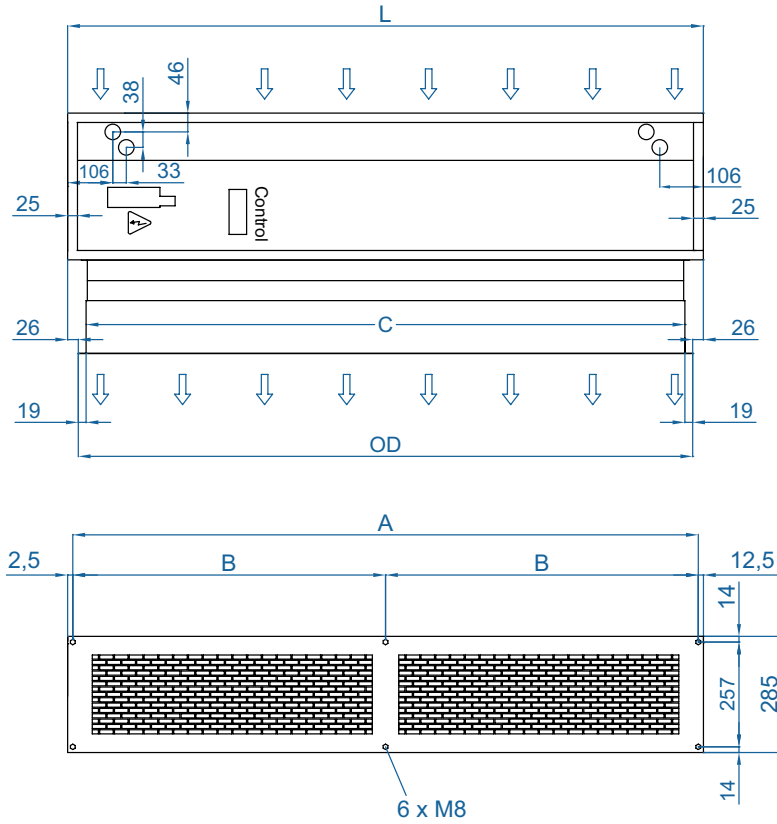

Invisair	L	A	B	C	OD
1000	1050	1025	.	961	998
1500	1550	1525	762,5	1461	1498
2000	2055	2030	1015	1961	1998
2500	2555	2530	1265	2461	2498
3000	3000	2975	1487,5	2961	2998

Bajo pedido, medidas personalizables

Instalación vertical

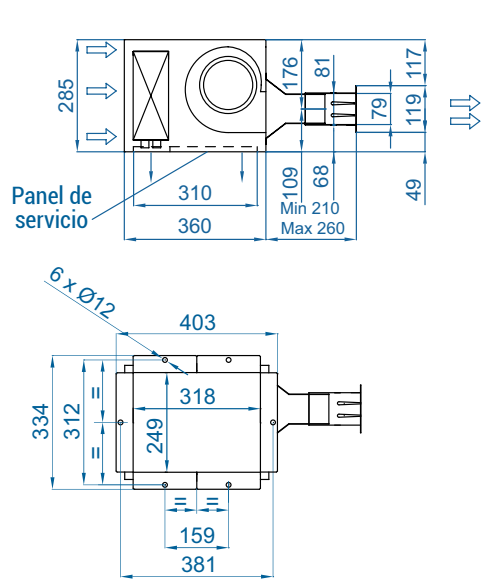
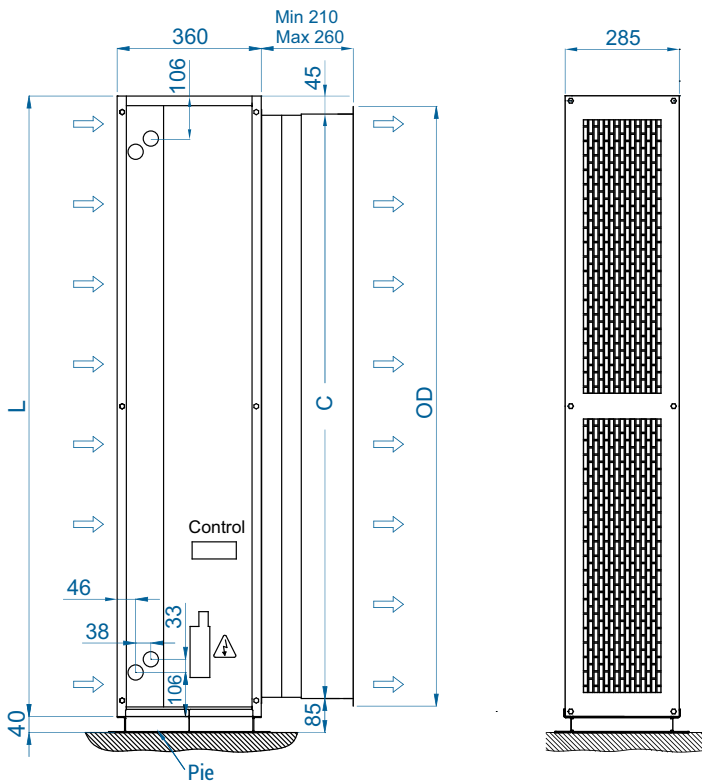

Planos CAD, archivos BIM, manuales de instalación y otra documentación



Configuraciones de instalación



Accesorios opcionales

Soportes e instalación



Soportes rail
SPWR

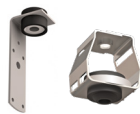

Soportes silentblock
SPANG-SIL / SLB



Cables de
suspensión SPCT



Soporte escuadra
Invisair MG



Reja perfil plano

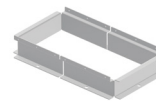

Soporte pie
SPF-INVISAIR
(Galv.)



Kit de unión
SPJ-INVISAIR
(Galv.)

Control



Control IR
✓ Incluido



Control básico
✓ Incluido



Kit Control Clever



Cable RJ45
✓ Incluido



Hand-Auto
CH-5HW-NE



Termostato ambiente
T6360



Kit Interface
IN-NE-II

Filtros



Prefiltro
extraíble G2

Sensores y válvulas



Contacto de puerta
magnético MAG-DC



Contacto de puerta
mecánico MEC-DC



Sensor temperatura
externa (Control Clever)



Válvula solenoide
V-S



Válvula 3 vías
V-T



Válvula proporcional
V-ACT



Sensor anticongelación
AFS-INS

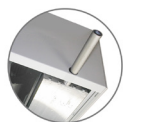

Bandeja
condensación

Condensación