

Properties of the Compact Ventilation Units

Type: SupraBox Comfort

Hygiene Requirements

The SupraBox Comfort Compact Ventilation Units conform to the current version the norm according to VDI 6022. The units have smooth surfaces (coil coated inside and out – RAL 7035) and are easily cleaned.

Housing

The units contain a sturdy frameless housing. The sidewalls have a double-layered design. The inside and outside metal sheets are made from 1 mm galvanized (coated) steel plate. The insulation thickness is 40 mm for ceiling units and 60mm for stand-alone units.

Heat Recovery

High efficiency counter flow heat exchangers with over 90% efficiency are utilized for heat recovery. Complete separation supply air and return air without odor transfer is ensured.

Filter

Fine dust filters of filter class F7 for supply air and class M5 (formerly F5) for return air are utilized for serial production. Quick release fasteners make changing filters fast and easy.

Pipe and Duct Connections

The connections are designed for ample room. The connection sizes are the same as the industry standard sizes.

EC-Fans

EC-fans in compact design with modern EC-motors from in-house production make for quiet and energy efficient operation across the entire product line. For temporary increased performance an optional boost-mode is available (upon request).

Accessories (optional)

For units from the SupraBox Comfort line an optional heating and cooling coil (hot water/cold water) for raising or lowering the room temperature is available. Furthermore additional electronic pre-/supplementary heating coils are offered.

Integrated Controller

The SupraBox Compact Ventilation Units are equipped with an integrated controller as standard.

All internal components are already pre-wired. Temperature control is possible with an optionally available heater/cooler. Many control functions are integrated into the software and can easily be subsequently activated. A control until for setting operating parameters is enclosed as standard.



Hot water Heater coil of the Construction Line SupraBox Comfort



Hot water Heater coil of the Construction Line SupraBox Comfort



Control of the SupraBox Comfort Line

Efficiency of the Heat Recovery

The SupraBox-Units are equipped with high efficiency cross counter flow plate heat exchangers made from corrosion-resistant aluminum. The actual efficiency ratings that can be attained depend primarily on the operating conditions.

Outdoor Air Temperature and Return Air Humidity

During most times of the year the humidity of the return air is irrelevant. If supply air and return air flow volumes are identical then the SupraBox attains efficiency ratings over 80%. With falling outdoor temperatures the surface temperature of the plate heat exchanger also falls. If this temperature falls below the dew point of the return air, which is dependent on the absolute humidity of the return air, condensate forms on the plates of the plate heat exchanger. The condensation energy of the water increases the efficiency level related to the supply air of the plate heat exchanger. Given equalized air flow volumes, extremely high efficiency ratings over 90% can be attained.

The accompanying graphic gives an overview of the efficiency rating of the heat recovery of a SupraBox 800 H at:

- Supply and return air flow each 550 m³/h
- Return air temperature 22°C

Due to the extremely high efficiency rating of the heat recovery, antifreeze measures are necessary at very cold temperatures. The different possibilities the SupraBox offers in such a case can be found in the description of the antifreeze plan (see page 3). In applications with low humidity in the return air, the undiminished operation of the heat recovery up to and below -10°C is possible. If the return air originates from humid rooms, antifreeze measures need to be taken at temperatures starting as low as -5°C. The energy efficiency of the heat recovery falls

Air Flow Volume of the SupraBox

The higher the air speed in the plate heat exchanger, the higher the heat recovery efficiency. See accompanying graphic (SupraBox 800 H, Outdoor Temperature -5°C / 90%, Return air 22°C / 55%).

Consequently selecting a generously sized SupraBox not only affects the performance of the unit due to lower pressure loss, but also a higher efficiency rating of up to 6% of the heat recovery.

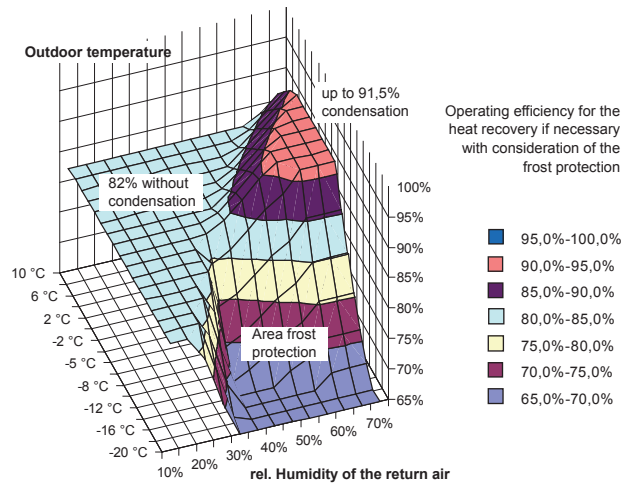

accordingly. Since the mean outdoor temperature in Central Europe during the heating period generally lies clearly above 0°C, antifreeze measures will be required on very few days of the year. Consequently energy efficiency rating reductions in this area have a diminished influence over the efficiency rating of the unit for the year as a whole.

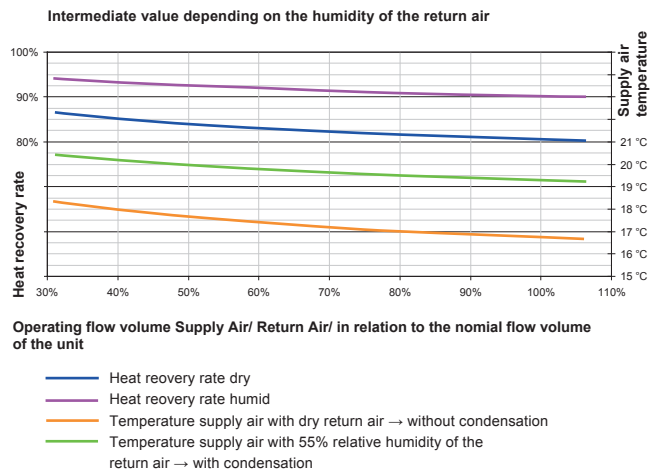

Level of Return Air Volume in relation to Supply Air Volume

The level of the return air volume in correlation to the supply air also has a strong influence on the efficiency of the heat recovery. If the return air volume is reduced compared to the supply air volume, then the efficiency rating of the heat recovery with regards to the supply air is also decreased. By looking at the resulting ventilation heat loss, an assessment is made possible of the higher return air in regards to the supply air. Since the entire air volume in the room to be ventilated increases, a higher return air volume has far greater influence on the loss in efficiency than a lower one (see accompanying graphic). Consequently one should aspire to have equalized air flow volumes of supply and return air for normal operation (not when defrosting the heat recovery) as far as the application allows.

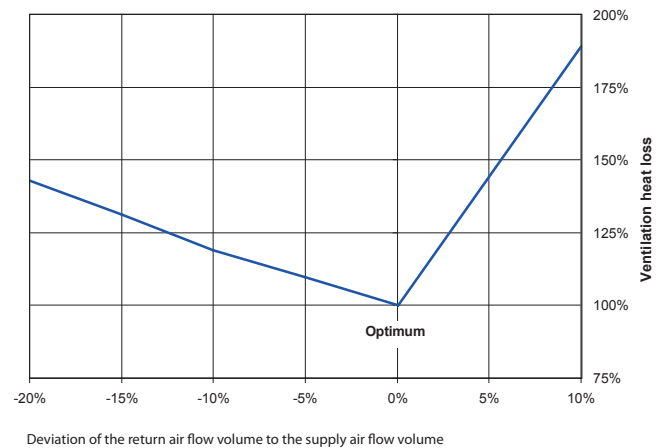

Estimating the Supply Air Temperature at the Discharge of the SupraBox

The accompanying graphic allows for a rough estimation of the attainable supply air temperatures of the SupraBox. It is valid for equalized air flow volumes and a return air temperature of 22°C. The baseline dry efficiency rating of the heat recovery is 80% and represents the minimum of the SupraBox product line at these conditions. If the absolute humidity of the return air (in the case of a winter configuration) is under 4g/kg, then supplementary heating that might be required can be selected here. Low air changes and ideal air movement can mean that given the high heat recovery rating of the SupraBox, supplementary heat might not be necessary. We can provide an exact calculation with your parameters with our air handling unit selection program. Please inquire if interested.

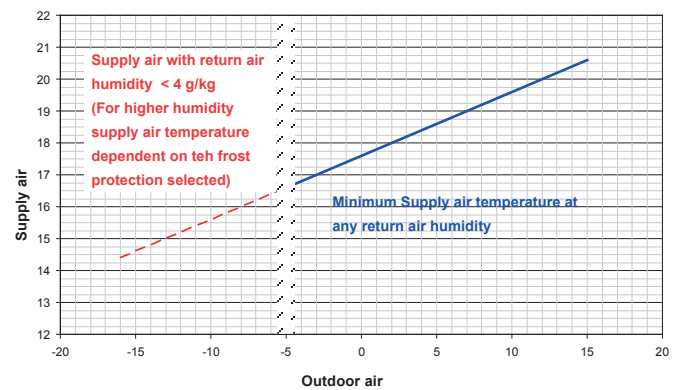

Antifreeze Plan / Antifreeze Protection

This function is divided into numerous sequences:

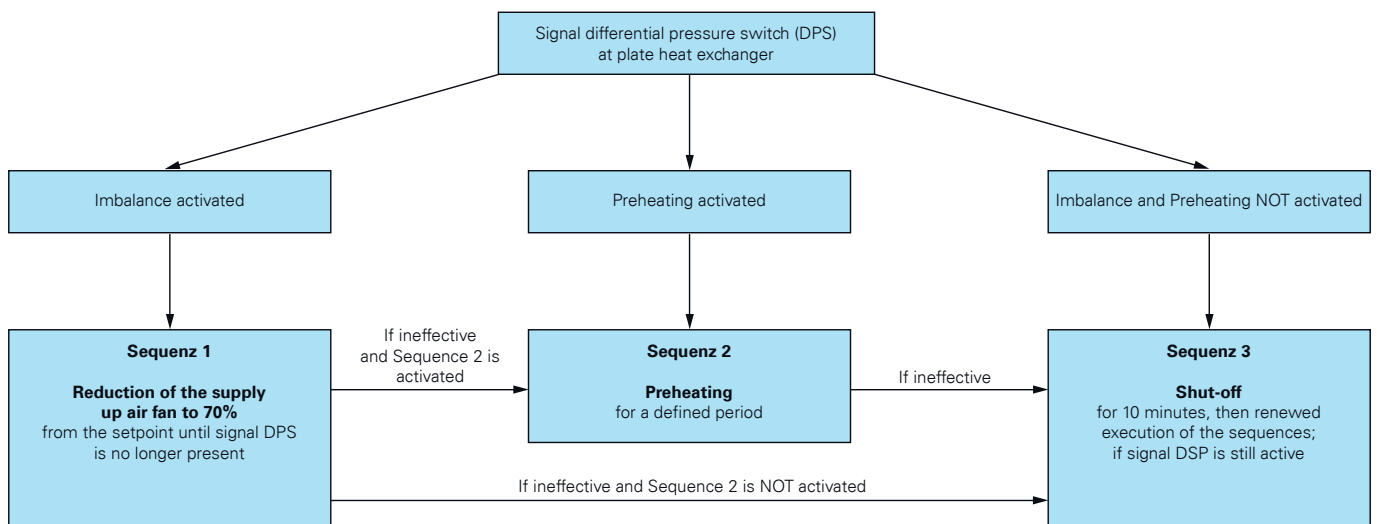



Standard equipment:

- frameless housing with 60 mm insulation
- coil coated inside and out (RAL 7035)
- conforms to VDI 6022
- integrated control (Plug & Play)
- horizontal connections
- energy efficient EC-fans
- high efficiency heat recovery
- 2 service doors; bypass
- interior installation

Technical Specifications: SupraBox 800 H

Part Number (please note the connection side supply air connections LEFT/RIGHT!)	SB080HGLIB00 (LEFT) ; SB080HGRIB00 (RIGHT)
Weather-Proof Model (please note the connection side supply air connections LEFT/RIGHT!)	SB080HGLWB00 (LEFT) ; SB080HGRWB00 (RIGHT)
Dimensions (L x H x T)	1330 x 1220 x 640 mm incl. controller box and adjustable feet
Operating Point Air flow volume V_{nenn} ext. pressure increase	800 m ³ /h 150 Pa
Fans Voltage Max. power consumption RPM Wattage SFP-class	Free running impeller with backward curved blades, driven by high efficiency EC-external rotor motors with integrated electronics 230 V / 50 Hz 3 A 2200 min ⁻¹ 2 x 200 W SFP 2
	
Heat Recovery Efficiency Rating [%]	Cross flow plate heat exchanger up to 92% *, corresponding to heat recovery class H1 * = maximum value at condensation; efficiency rating is dependent upon operating condition
Air Filter	Panel filter with plastic frame; Supply air: F7 / Exhaust air: M5 (formerly F5) 493 x 418 x 96 mm
Air Connections Diameter Duct Air Speed	horizontal ø 315 2,9 m/s
Control	Supply air / Return air / Room temperature control, Fans steplessly adjustable, Bypass function modulating 0-10V
Bypass	No control damper through the heat recovery, control damper through bypass
Weight incl. controller	215 kg
Max. air flow temperature	40°C (higher air flow temperature available upon request)

Air performance:

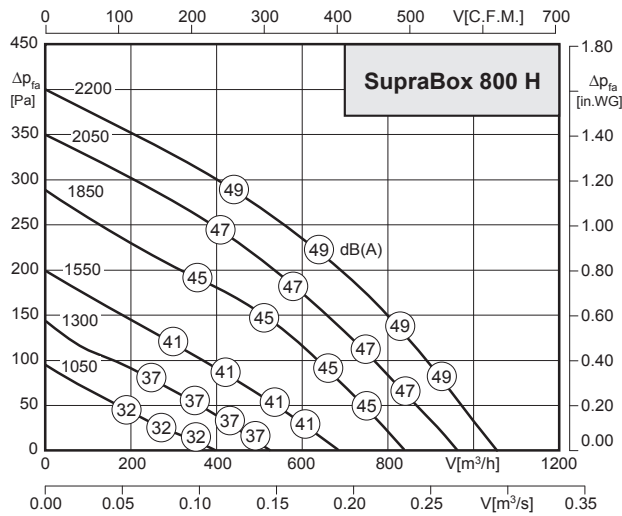

Sound power level:

The sound data represented in the air performance curve is the A-weighted apparent sound power level of the housing L_{WA2} in dB(A).

Pressure side apparent sound power level $LWA5 = LWA2 + 2$ dB

Discharge side apparent sound power level $LWA6 = LWA2 + 20$ dB

Calculation:

$LWA5$ per octave: $LWA5(Oct) = LWA5 +$ correction value (table row $LWA5$)

$LWA6$ per octave: $LWA6(Oct) = LWA6 +$ correction value (table row $LWA6$)

Correction value: $\Delta L_{W_{oct}}$ [dB]	fM [Hz]						
	125	250	500	1K	2K	4K	8K
$LWA5$ [dB(A)] Pressure side (Outdoor air / Exhaust air)	-15	-6	-4	-7	-10	-19	-28
$LWA6$ [dB(A)] Discharge side (Supply air / Extract air)	-21	-9	-8	-5	-5	-12	-21
$LWA2$ [dB(A)] Noise radiation from the housing	-4	-4	-11	-12	-13	-20	-25

Note: a detailed calculation example can be found on page 40

Dimensions:

All dimensions are in mm. The model in the drawing is shown with supply air connections LEFT. The model with supply air connections RIGHT is vertically mirrored. * Weather protection roof – only in the weather protected model. The weather protection roof protrudes 100 mm all the way around.

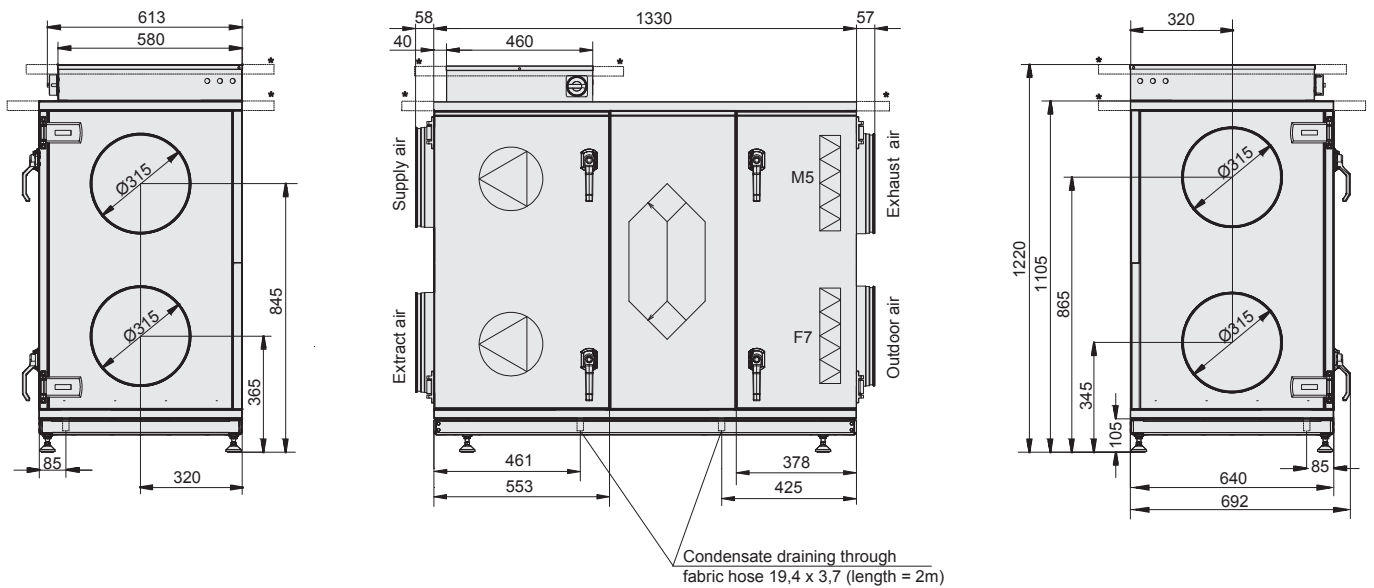

Accessories:

	F Flexible Ducts (Set of 4)	Page 29		PTC-Preheat Coil	Page 32
	Shut-off Damper (manual / motor driven)	Page 30		Hot Water Pump Reheat Coil	Page 33
	Duct Silencer	Page 29		Cold Water Pump Aftercooler	Page 33
	Electric Reheating Coil	Page 31		Additional electronic accessories (Temperature sensor, CO ₂ -sensor etc.)	Page 28



Standard equipment:

- frameless housing with 60 mm insulation
- coil coated inside and out (RAL 7035)
- conforms to VDI 6022
- integrated control (Plug & Play)
- horizontal connections
- energy efficient EC-fans
- high efficiency heat recovery
- 2 service doors; bypass
- interior installation

Technical Specifications: SupraBox 1100 H

Article No. (please note the connection side supply air connections LEFT/RIGHT!)	SB110HGLIB00 (LEFT) ; SB110HGRIB00 (RIGHT)
Weather-Proof Model (please note the connection side supply air connections LEFT/RIGHT!)	SB110HGLWB00 (LEFT) ; SB110HGRWB00 (RIGHT)
Dimensions (L x H x T)	1500 x 1420 x 660 mm incl. controller box and adjustable feet
Operating Point Air flow volume V_{nenn} ext. pressure increase	1.100 m ³ /h 200 Pa
Fans Voltage Max. power consumption RPM Wattage SFP-class	Free running impeller with backward curved blades, driven by high efficiency EC-external rotor motors with integrated electronics 230 V / 50 Hz 4 A 2600 min ⁻¹ 2 x 310 W SFP 2
Heat Recovery Efficiency Rating [%]	Cross-flow plate heat exchanger up to 92% *, corresponding to heat recovery class H1 * = maximum value at condensation; efficiency rating is dependent upon operating condition
Air Filter	Panel filter with plastic frame; Supply air: F7 / Exhaust air: M5 (formerly F5) 513 x 518 x 96 mm
Air Connections Diameter Duct Air Speed	horizontal ø 355 3,1 m/s
Control	Supply air / Exhaust Air / Room temperature control, Fans steplessly adjustable, Bypass function modulating 0-10V
Bypass	Counter flow control damper, control damper through bypass and through heat recovery
Weight incl. controller	260 kg
Max. air flow temperature	40°C (higher air flow temperature available upon request)



Air performance:

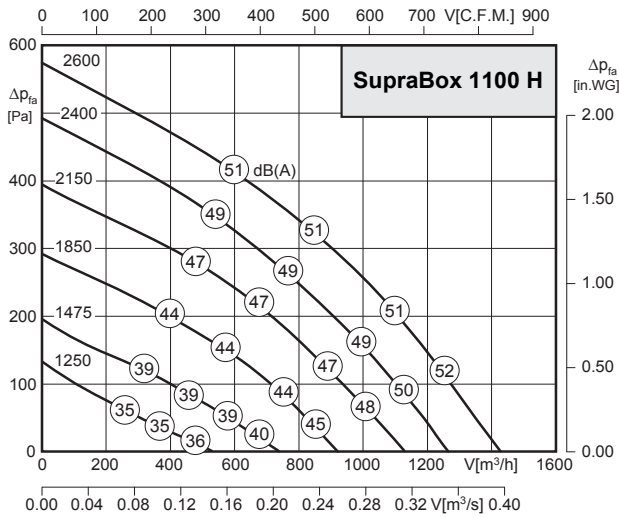

Sound power level:

The sound data represented in the air performance curve is the A-weighted apparent sound power level of the housing L_{WA2} in dB(A).

Pressure side apparent sound power level $LWA5 = LWA2 + 1$ dB
 Discharge side apparent sound power level $LWA6 = LWA2 + 24$ dB

Calculation:

$LWA5$ per octave: $LWA5(Ok) = LWA5 + \text{correction value (table row } LWA5)$

$LWA6$ per octave: $LWA6(Ok) = LWA6 + \text{correction value (table row } LWA6)$

Correction value: ΔL_{Wok} [dB]	fM [Hz]						
	125	250	500	1K	2K	4K	8K
$LWA5$ [dB(A)] Pressure side (Outdoor air / Exhaust air)	-17	-8	-4	-6	-8	-20	-30
$LWA6$ [dB(A)] Discharge side (Supply air / Extract air)	-26	-11	-9	-6	-4	-9	-19
$LWA2$ [dB(A)] Noise radiation from the housing	-8	-5	-6	-8	-10	-18	-21

Note: a detailed calculation example can be found on page 40

Dimensions:

All dimensions are in mm. The model in the drawing is shown with supply air connections LEFT. The model with supply air connections RIGHT is vertically mirrored. * Weather protection roof – only in the weather protected model. The weather protection roof protrudes 100 mm all the way around.

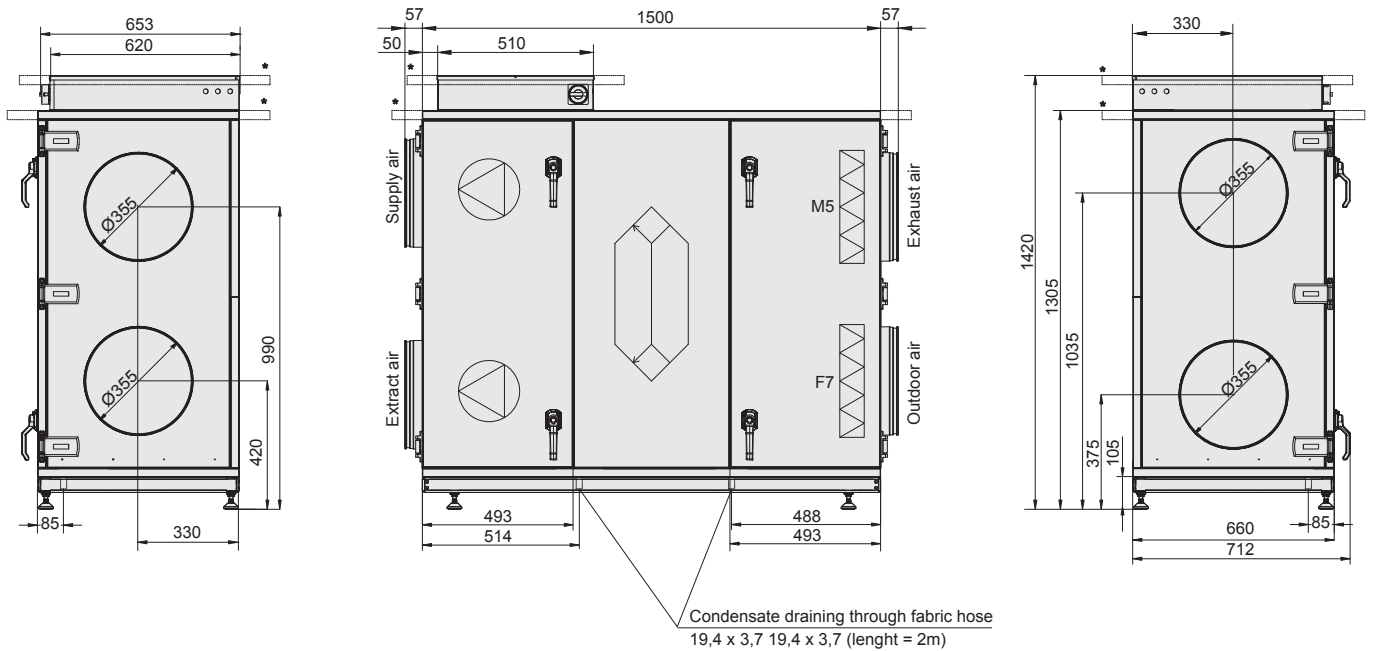

Accessories:

	Flexible Duct (Set of 4)	Page 29		PTC Preheat Coil	Page 32
	Shut-Off Damper (manual / motor driven)	Page 30		Hot Water Pump Reheat Coil	Page 33
	Duct Silencer	Page 29		Cold Water Pump Aftercooler	Page 33
	Electric Reheating Coil	Page 31		Additional electronic accessories (Temperature sensor, CO2 sensor etc.)	Page 28



Standard equipment:

- frameless housing with 60 mm insulation
- coil coated inside and out (RAL 7035)
- conforms to VDI 6022
- integrated control (Plug & Play)
- horizontal connections
- energy efficient EC-fans
- high efficiency heat recovery
- 2 service doors; bypass
- interior installation

Technical Specifications: SupraBox 1500 H

Article No. (please note the connection side supply air connections LEFT/RIGHT!)	SB150HGLIB00 (LEFT) ; SB150HGRIB00 (RIGHT)
Weather-Proof Model (please note the connection side supply air connections LEFT/RIGHT!)	SB150HGLWB00 (LEFT) ; SB150HGRWB00 (RIGHT)
Dimensions (L x H x T)	1670 x 1520 x 700 mm incl. controller box and adjustable feet
Operating Point Air flow volume V_{nenn} ext. pressure increase	1.500 m ³ /h 200 Pa
Fans Voltage Max. power consumption RPM Wattage SFP-class	Free running impeller with backward curved blades, driven by high efficiency EC-external rotor motors with integrated electronics 230 V / 50 Hz 6 A 2900 min ⁻¹ 2 x 470 W SFP 3
	
Heat Recovery Efficiency Rating [%]	Cross-flow plate heat exchanger up to 92% *, corresponding to heat recovery class H1 * = maximum value at condensation; efficiency rating is dependent upon operating condition
Air Filter	Panel filter with plastic frame; Supply air: F7 / Exhaust air: M5 (formerly F5) 553 x 568 x 96 mm
Air Connections Diameter Duct Air Speed	horizontal ø 400 3,3 m/s
Controller	Supply air / Exhaust air / Room temperature control, Fans steplessly adjustable, Bypass function modulating 0-10V
Bypass	Counter flow control damper, control damper through bypass and through heat recovery
Weight incl. controller	298 kg
Max. air flow temperature	40°C (higher air flow temperature available upon request)

Air performance:

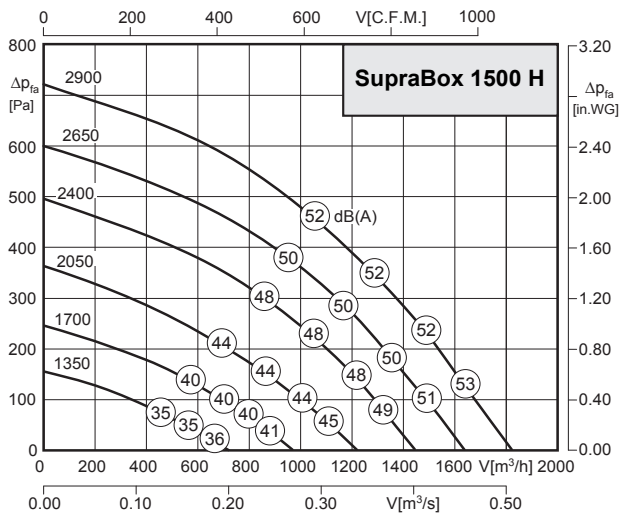

Sound power level:

The sound data represented in the air performance curve is the A-weighted apparent sound power level of the housing L_{WA2} in dB(A).

Pressure side apparent sound power level $LWA5 = LWA2 + 4$ dB
 Discharge side apparent sound power level $LWA6 = LWA2 + 27$ dB

Calculation:

$LWA5$ per octave: $LWA5(Okt) = LWA5 +$ correction value (table row $LWA5$)

$LWA6$ per octave: $LWA6(Okt) = LWA6 +$ correction value (table row $LWA6$)

Correction value: ΔL_{Wokt} [dB]	fM [Hz]						
	125	250	500	1K	2K	4K	8K
$LWA5$ [dB(A)] Pressure side (Outdoor air / Exhaust air)	-16	-12	-6	-4	-7	-12	-25
$LWA6$ [dB(A)] Discharge side (Supply air / Extract air)	-24	-15	-11	-7	-4	-6	-14
$LWA2$ [dB(A)] Noise radiation from the housing	-7	-5	-7	-8	-10	-15	-26

Note: a detailed calculation example can be found on page 40

Dimensions:

All dimensions are in mm. The model in the drawing is shown with supply air connections LEFT. The model with supply air connections RIGHT is vertically mirrored. * Weather protection roof – only in the weather protected model. The weather protection roof protrudes 100 mm all the way around.

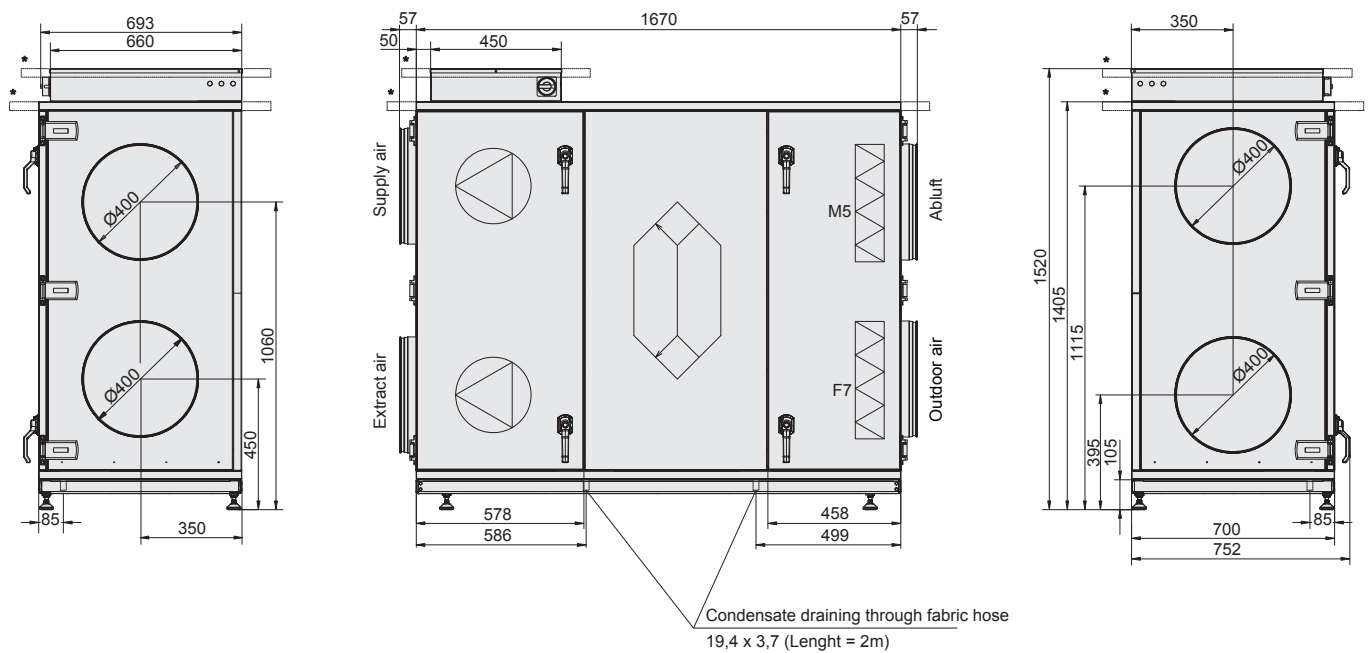

Accessories:

	Flexible Duct (Set of 4)	Page 29		Electronic Preheat Coil	Page 33
	Shut-Off Damper (manual / motor driven)	Page 30		Hot Water Pump Reheat Coil	Page 33
	Duct Silencer	Page 29		Cold Water Pump Aftercooler	Page 33
	Electric Reheating Coil	Page 31		Additional electronic accessories (Temperature sensor CO ₂ -sensor etc.)	Page 28



Standard equipment:

- frameless housing with 60 mm insulation
- coil coated inside and out (RAL 7035)
- conforms to VDI 6022
- integrated control (Plug & Play)
- horizontal connections
- energy efficient EC-fans
- high efficiency heat recovery
- 2 service doors; bypass
- interior installation

Technische Daten: SupraBox 2000 H

Article No. (please note the connection side supply air connections LEFT/RIGHT!)	SB200HGLIB00 (LEFT) ; SB200HGRIB00 (RIGHT)
Weather-Proof Model (please note the connection side supply air connections LEFT/RIGHT!)	SB200HGLWB00 (LEFT) ; SB200HGRWB00 (RIGHT)
Dimensions (L x H x T)	1800 x 1660 x 760 mm incl. controller box and adjustable feet
Operating Point Air flow volume V_{nenn} ext. pressure increase	2.000 m ³ /h 250 Pa
Fans	Free running impeller with backward curved blades, driven by high efficiency EC-external rotor motors with integrated electronics
Voltage	230 V / 50 Hz
Max. power consumption	10 A
RPM	2450 min ⁻¹
Wattage	2 x 800 W
SFP-class	SFP 3
Heat Recovery Efficiency Rating [%]	Cross-flow plate heat exchanger up to 92% *, corresponding to heat recovery class H1 * = maximum value at condensation; efficiency rating is dependent upon operating condition
Air Filter	Panel filter with plastic frame; Supply air: F7 / Exhaust air: M5 (formerly F5) 592 x 592 x 96 mm
Air Connections Diameter Duct Air Speed	horizontal ø 400 4,4 m/s
Controller	Supply air / Exhaust Air / Room temperature control, Fans steplessly adjustable, Bypass function modulating 0-10V
Bypass	Counter flow control damper, control damper through bypass and through heat recovery
Weight incl. controller	377 kg
Max. air flow temperature	40°C (higher air flow temperature available upon request)



Air performance:

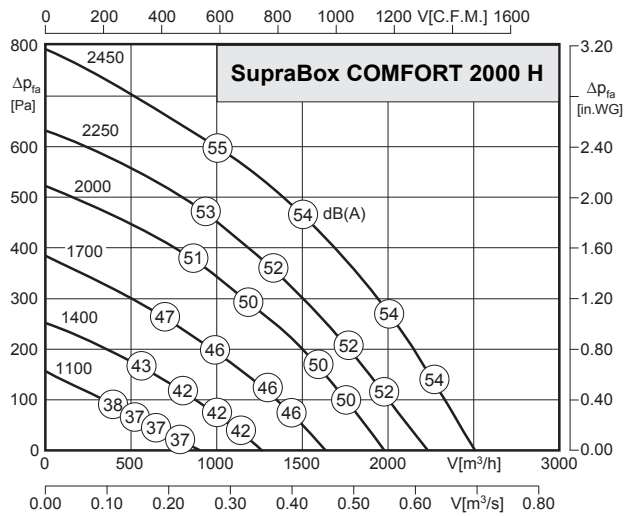

Sound power level:

The sound data represented in the air performance curve is the A-weighted apparent sound power level of the housing L_{WA2} in dB(A).

Pressure side apparent sound power level $L_{WA5} = L_{WA2} + 2$ dB

Discharge side apparent sound power level $L_{WA6} = L_{WA2} + 25$ dB

Calculation:

L_{WA5} per Octave: $L_{WA5(Okt)} = L_{WA5} + \text{correction value (table row } L_{WA5})$

L_{WA6} per Octave: $L_{WA6(Okt)} = L_{WA6} + \text{correction value (table row } L_{WA6})$

Korrekturwerte: ΔL_{WOk} [dB]	fM [Hz]						
	125	250	500	1K	2K	4K	8K
L_{WA5} [dB(A)] Pressure side (Outdoor air / Exhaust air)	-15	-9	-4	-5	-9	-22	-30
L_{WA6} [dB(A)] Discharge side (Supply air / Extract air)	-22	-13	-11	-5	-4	-9	-16
L_{WA2} [dB(A)] Noise radiation from the housing	-5	-7	-8	-9	-10	-12	-23

Note: a detailed calculation example can be found on page 40

Dimensions:

All dimensions are in mm. The model in the drawing is shown with supply air connections LEFT. The model with supply air connections RIGHT is vertically mirrored. * Weather protection roof – only in the weather protected model. The weather protection roof protrudes 100 mm all the way around.

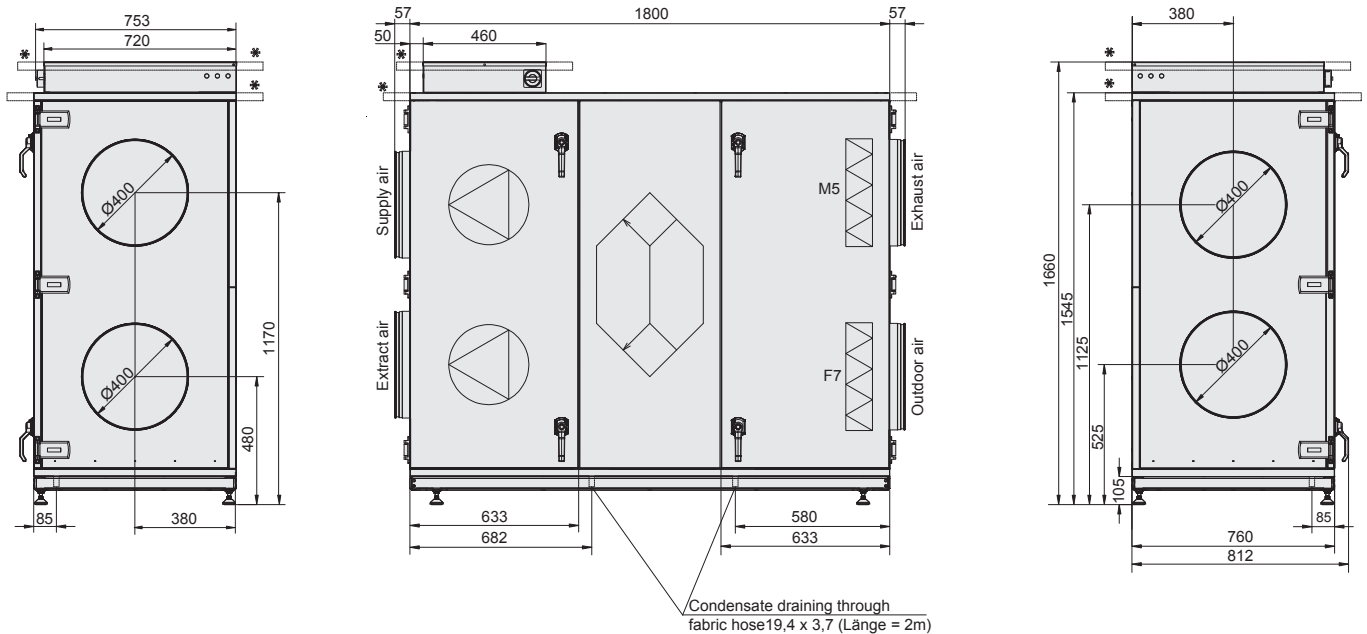

Accessories:

	Flexible Duct (Set of 4)	Page 29		Electronic Preheat Coil	Page 33
	Shut-Off Damper (manual / motor driven)	Page 30		Hot Water Pump Reheat Coil	Page 33
	Duct Silencer	Page 29		Cold Water Pump Aftercooler	Page 33
	Electric Reheating Coil	Page 31		Additional electronic accessories (Temperature sensor, CO ₂ -sensor etc.)	Page 28



SupraBox
COMFORT

Standard equipment:

- frameless housing with 60 mm insulation
- coil coated inside and out (RAL 7035)
- conforms to VDI 6022
- integrated control (Plug & Play)
- horizontal connections
- energy efficient EC-fans
- high efficiency heat recovery
- 2 service doors; bypass
- interior installation (weather proof model available upon request)

Technical Specifications: SupraBox 3500 H

Article No. (please note the connection side supply air connections LEFT/RIGHT!)	SB350HGLIB00 (LEFT) ; SB350HGRI00 (RIGHT)
Dimensions (L x H x T)	2320 x 1925 x 840 mm incl. adjustable feet
Operating Point Air flow volume V_{nenn} ext. pressure increase	3500 m ³ /h 400 Pa
Fans Voltage Max. power consumption RPM Wattage SFP-class	Free running impeller with backward curved blades, driven by high efficiency EC-external rotor motors with integrated electronics 400 V / 50 Hz 5,0 A 2330 min ⁻¹ 2 x 1600 W SFP 4
	
Heat Recovery Efficiency Rating [%]	Cross-flow plate heat exchanger up to 92% *, corresponding to heat recovery class H1 * = maximum value at condensation; efficiency rating is dependent upon operating condition
Air filter	Panel filter with plastic frame; Supply air: F7 / Exhaust air: M5 (formerly F5) 693 x 828 x 96 mm
Air Connections Diameter Duct Air Speed	horizontal 598 x 598 mm (30 mm Flansch) 2,7 m/s
Controller	Supply air / Exhaust air / Room temperature control, Fans steplessly adjustable, Bypass function modulating 0-10V
Bypass	No control damper through the heat recovery, control damper through bypass
Weight incl. controller	530 kg
Max. air flow temperature	40°C (higher air flow temperature available upon request)

Air performance:

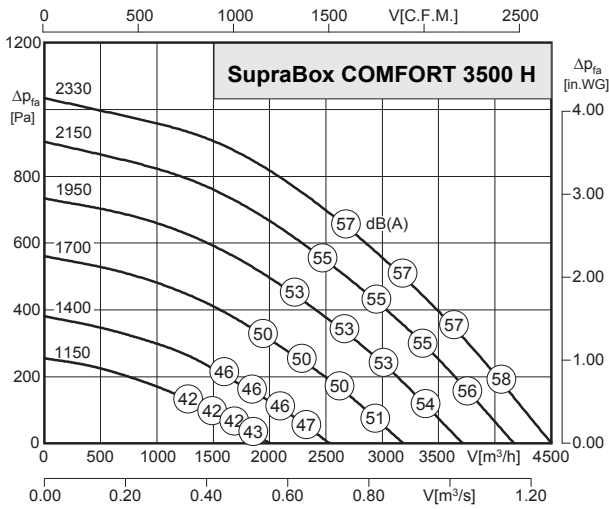

Sound power level:

The sound data represented in the air performance curve is the A-weighted apparent sound power level of the housing L_{WA2} in dB(A).

Pressure side apparent sound power level $LWA5 = LWA2 + 4$ dB
 Discharge side apparent sound power level $LWA6 = LWA2 + 28$ dB

Calculation:

$LWA5$ per octave: $LWA5(Okt) = LWA5 + \text{correction value (table row } LWA5)$

$LWA6$ per octave: $LWA6(Okt) = LWA6 + \text{correction value (table row } LWA6)$

Correction value: ΔL_{Wokt} [dB]	f [Hz]						
	125	250	500	1K	2K	4K	8K
$LWA5$ [dB(A)] Pressure side (Outdoor air / Exhaust air)	-26	-8	-3	-6	-11	-22	-27
$LWA6$ [dB(A)] Discharge side (Supply air / Extract air)	-39	-14	-12	-5	-4	-8	-16
$LWA2$ [dB(A)] Noise radiation from the housing	-13	-5	-6	-7	-10	-12	-20

Note: a detailed calculation example can be found on page 40

Dimensions:

All dimensions are in mm. The model in the drawing is shown with supply air connections LEFT. The model with supply air connections RIGHT is vertically mirrored.

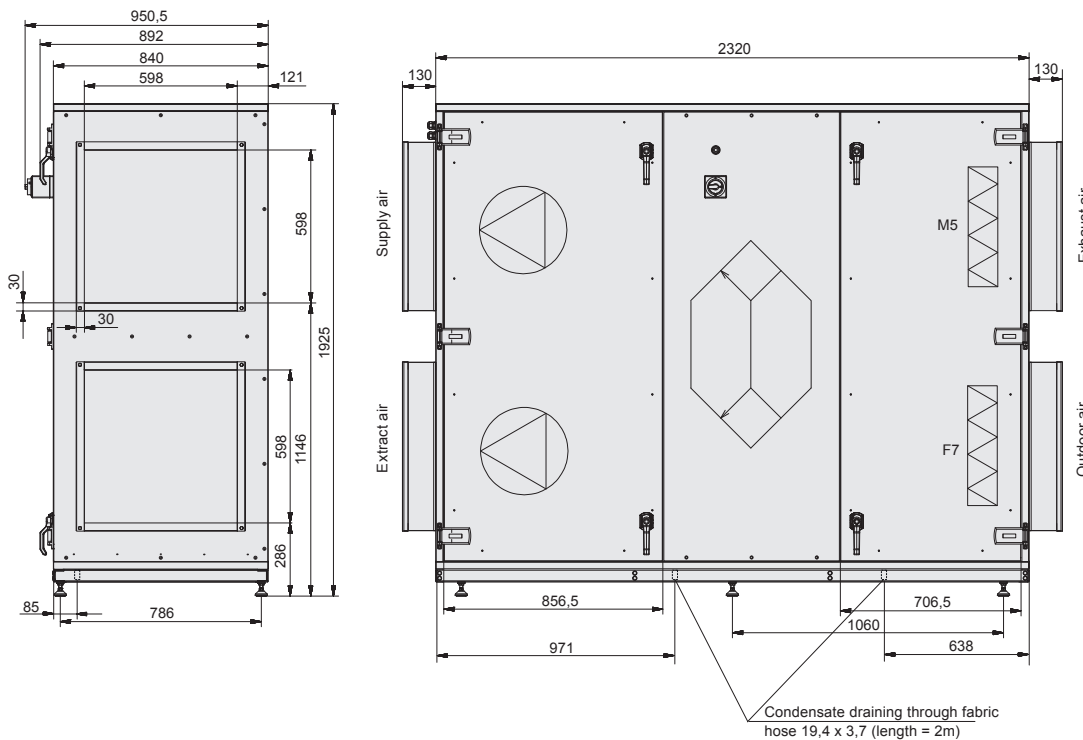

Accessories available upon request

The SupraBox 3500 H is outfitted with sound dampening connection ends. Isolation from the duct network is provided for. Accessories like silencers as well as heating and cooling coils are usually laid out by the system installer. For this reason a standardized assignment is not possible.



Standard equipment:

- frameless housing with 60 mm insulation
- coil coated inside and out (RAL 7035)
- conforms to VDI 6022
- integrated control (Plug & Play)
- vertical connections
- energy efficient EC-fans
- high efficiency heat recovery
- 2 service doors; bypass
- interior installation

Technical Specifications: SupraBox 800 V

Part number (Connections side)	SB080VGRI00 (RIGHT)
Dimensions (L x H x T)	1470 x 1145 x 600 mm incl. adjustable feet
Operating Point Air flow volume V_{nenn} ext. pressure increase	800 m ³ /h 150 Pa
Fans Voltage Max. power consumption RPM Wattage SFP-class	Free running impeller with backward curved blades, driven by high efficiency EC-external rotor motors with integrated electronics 230 V / 50 Hz 3 A 2300 min ⁻¹ 2 x 225 W SFP 2
	
Heat Recovery Wirkungsgrad [%]	Cross-flow plate heat exchanger up to 92% *, corresponding to heat recovery class H1 * = maximum value at condensation; efficiency rating is dependent upon operating condition
Air Filter	Panel filter with plastic frame; Supply air: F7 / Exhaust air: M5 (formerly F5) 328 x 478 x 96 mm
Air Connections Diameter Duct Air Speed	vertical ø 250 4,5 m/s
Controller	Supply air / Return air / Room temperature control, Fans steplessly adjustable, Bypass function modulating 0-10V
Bypass	No control damper through the heat recovery, control damper through bypass
Weight incl. controller	209 kg
Max. air flow temperature	40°C (higher air flow temperature available upon request)

Air performance:

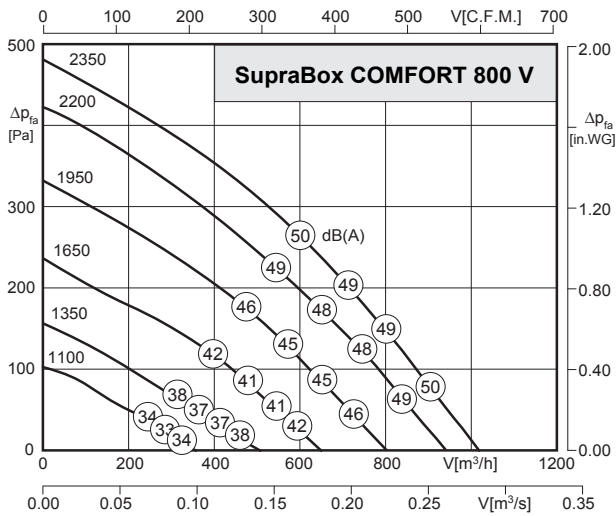

Sound power level:

The sound data represented in the air performance curve is the A-weighted apparent sound power level of the housing L_{WA2} in dB(A).

Pressure side apparent sound power level $LWA5 = LWA2 + 2$ dB
 Discharge side apparent sound power level $LWA6 = LWA2 + 22$ dB

Calculation:

$LWA5$ per octave: $LWA5(Ok) = LWA5 +$ correction value (table row $LWA5$)

$LWA6$ per octave: $LWA6(Ok) = LWA6 +$ correction value (table row $LWA6$)

Correction value: ΔL_{Wok} [dB]	fM [Hz]						
	125	250	500	1K	2K	4K	8K
$LWA5$ [dB(A)] Pressure side (Outdoor air / Exhaust air)	-16	-2	-8	-10	-11	-21	-30
$LWA6$ [dB(A)] Discharge side (Supply air / Extract air)	-28	-11	-9	-6	-3	-14	-22
$LWA2$ [dB(A)] Noise radiation from the housing	-9	-2	-10	-12	-14	-19	-25

Note: a detailed calculation example can be found on page 40

Dimensions:

All dimensions are in mm. The model in the drawing is shown with supply air connections RIGHT.

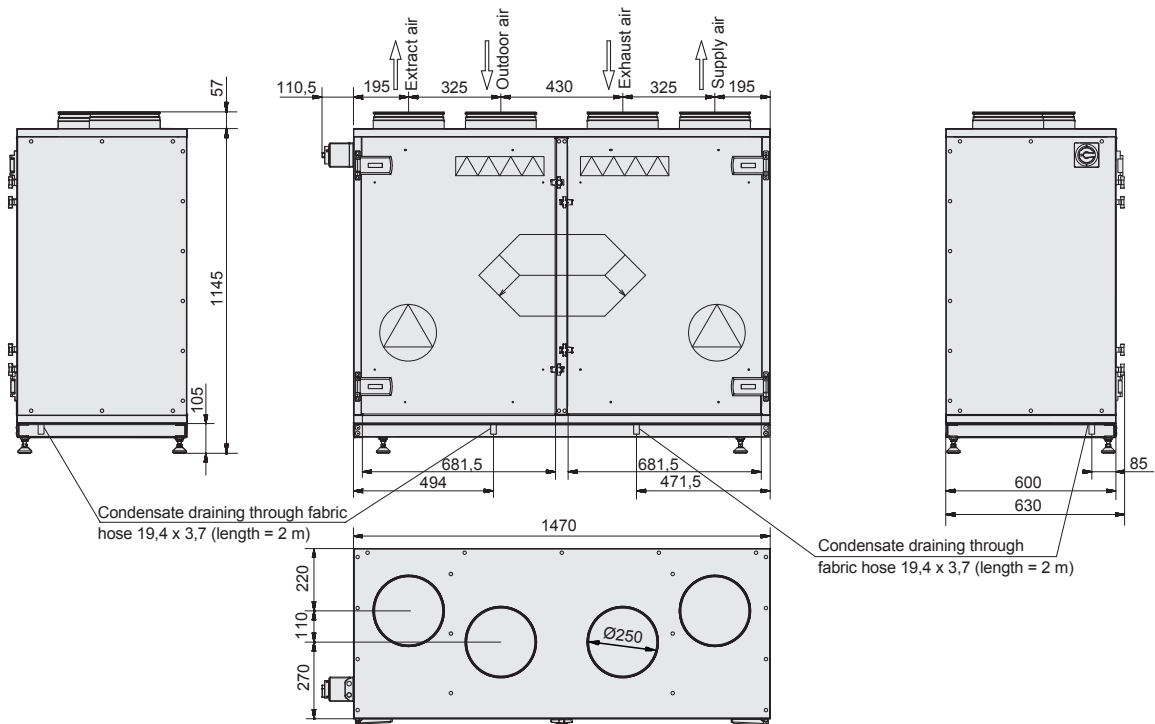

Accessories:

	Flexible Duct (Set of 4)	Page 29		PTC Preheat Coil	Page 32
	Shut-Off Damper (manual / motor driven)	Page 30		Hot Water Pump Reheat Coil	Page 33
	Duct Silencer	Page 29		Cold Water Pump Aftercooler	Page 33
	Electric Reheating Coil	Page 31		Additional electronic accessories (Temperature sensor, CO2 sensor etc.)	Page 28



Standard equipment:

- frameless housing with 60 mm insulation
- coil coated inside and out (RAL 7035))
- conforms to VDI VDI 6022
- integrated control (Plug & Play)
- vertical connections
- energy efficient EC-fans
- high efficiency heat recovery
- 2 service doors; bypass
- interior installation

Technical Specifications: SupraBox 1100 V

Article No. (Connections side)	SB110VGRIB00 (RIGHT)
Dimensions (L x H x T)	1740 x 1225 x 630 mm incl. adjustable feet
Operating Point Air flow volume V_{nenn} ext. pressure increase	1.100 m ³ /h 200 Pa
Fans Voltage Max. power consumption RPM Wattage SFP-class	Free running impeller with backward curved blades, driven by high efficiency EC-external rotor motors with integrated electronics 230 V / 50 Hz 4 A 2600 min ⁻¹ 2 x 320 W SFP 2
	
Heat Recovery Efficiency Rating [%]	Cross-flow plate heat exchanger up to 92% *, corresponding to heat recovery class H1 * = maximum value at condensation; efficiency rating is dependent upon operating condition
Air Filter	Panel filter with plastic frame; Supply air: F7 / Exhaust air: M5 (formerly F5) 398 x 508 x 96 mm
Air Connections Diameter Duct Air Speed	vertical ø 315 3,9 m/s
Controller	Supply air / Return air / Room temperature control, Fans steplessly adjustable, Bypass function modulating 0-10V
Bypass	No control damper through the heat recovery, control damper through bypass
Weight incl. controller	253 kg
Max. air flow temperature	40°C (higher air flow temperature available upon request)

Air performance:

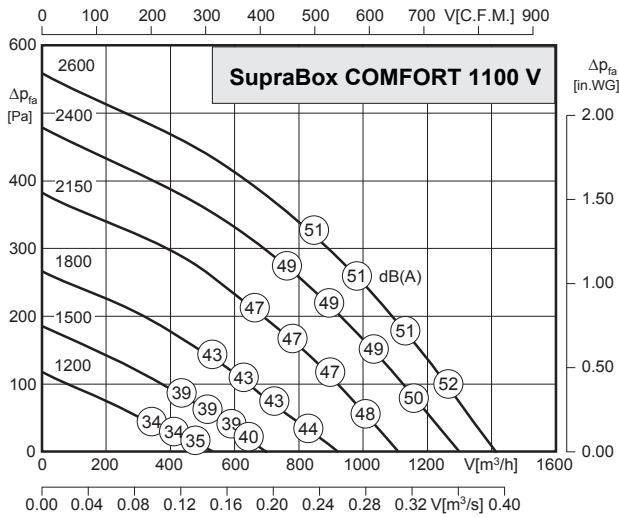

Sound power level:

The sound data represented in the air performance curve is the A-weighted apparent sound power level of the housing L_{WA2} in dB(A).

Pressure side apparent sound power level $L_{WA5} = L_{WA2} + 2$ dB
 Discharge side apparent sound power level $L_{WA6} = L_{WA2} + 23$ dB

Calculation:

L_{WA5} per octave: $L_{WA5(Ok)} = L_{WA5} + \text{correction value (table row } L_{WA5})$

L_{WA6} per octave: $L_{WA6(Ok)} = L_{WA6} + \text{correction value (table row } L_{WA6})$

Correction value: ΔL_{Wok} [dB]	fM [Hz]						
	125	250	500	1K	2K	4K	8K
L_{WA5} [dB(A)] Pressure side (Outdoor air / Exhaust air)	-14	-8	-4	-6	-9	-20	-31
L_{WA6} [dB(A)] Discharge side (Supply air / Extract air)	-26	-10	-8	-6	-5	-8	-16
L_{WA2} [dB(A)] Noise radiation from the housing	-6	-4	-9	-10	-13	-18	-25

Note: a detailed calculation example can be found on page 40

Dimensions:

All dimensions are in mm. The model in the drawing is shown with supply air connections RIGHT.

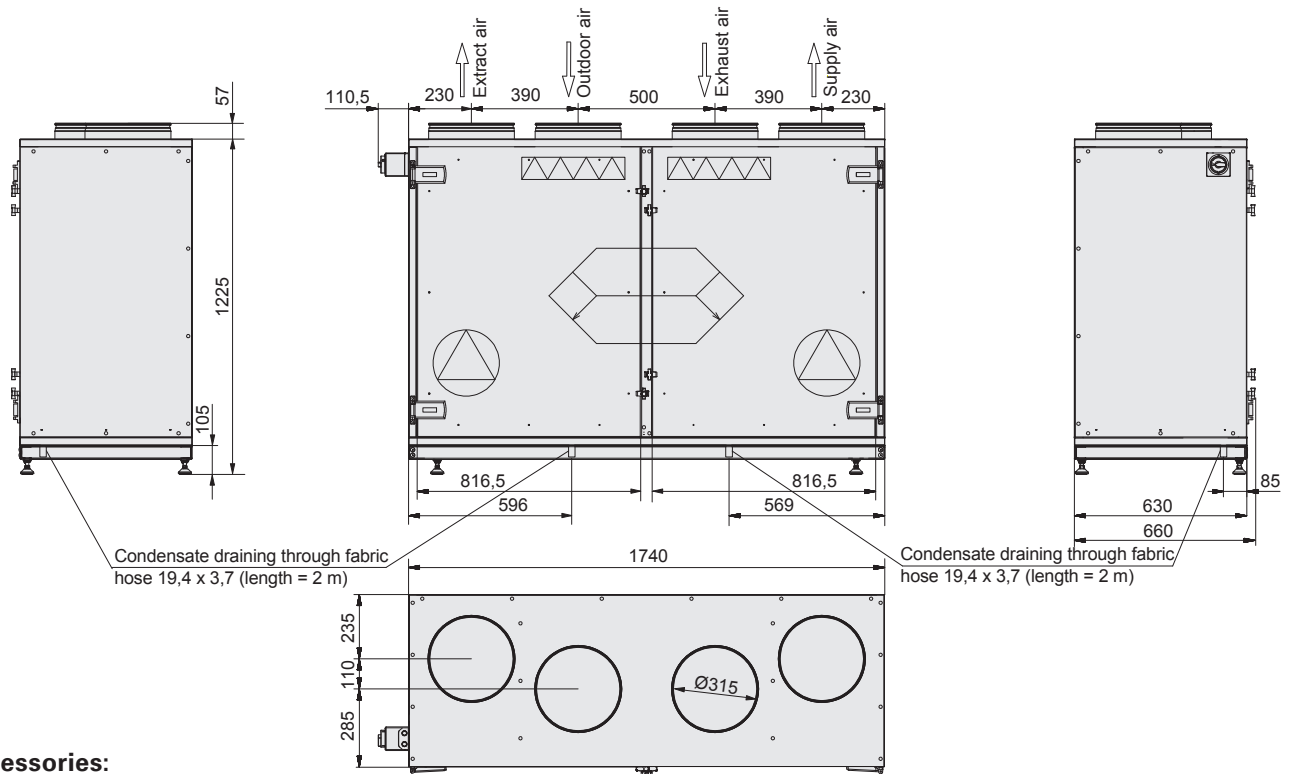

Accessories:

	Flexible Duct (Set of 4)	Page 29		PTC Preheat Coil	Page 32
	Shut-Off Damper (manual / motor driven)	Page 30		Hot Water Pump Reheat Coil	Page 33
	Duct Silencer	Page 29		Cold Water Pump Aftercooler	Page 33
	Electric Reheating Coil	Page 31		Additional electronic accessories (Temperature sensor, CO ₂ -sensor etc.)	Page 28



Standard equipment:

- frameless housing with 60 mm insulation
- coil coated inside and out (RAL 7035)
- conforms to VDI 6022
- integrated control (Plug & Play)
- vertical connections
- energy efficient EC-fans
- high efficiency heat recovery
- 2 service doors; bypass
- interior installation

Technical Specifications: SupraBox 1500 V

Article No. (Connections side)	SB150VGRIB00 (RIGHT)
Dimensions (L x H x T)	1980 x 1365 x 710 mm incl. adjustable feet
Operating Point Air flow volume V_{nenn} ext. pressure increase	1.500 m ³ /h 200 Pa
Fans Voltage Max. power consumption RPM Wattage SFP-class	Free running impeller with backward curved blades, driven by high efficiency EC-external rotor motors with integrated electronics 230 V / 50 Hz 6 A 2900 min ⁻¹ 2 x 475 W SFP 3
	
Heat Recovery Efficiency Rating [%]	Cross-flow plate heat exchanger up to 92% *, corresponding to heat recovery class H1 * = maximum value at condensation; efficiency rating is dependent upon operating condition
Air Filter	Panel filter with plastic frame; Supply air: F7 / Return air: M5 (formerly F5) 468 x 548 x 96 mm
Air Connections Diameter Duct Air Speed	vertical ø 355 4,2 m/s
Controller	Supply air / Exhaust air- / Room temperature control, Fans steplessly adjustable, Bypass function modulating 0-10V
Bypass	No control damper through the heat recovery, control damper through bypass
Weight incl. controller	315 kg
Max. air flow temperature	40°C (higher air flow temperature available upon request)

Air performance:

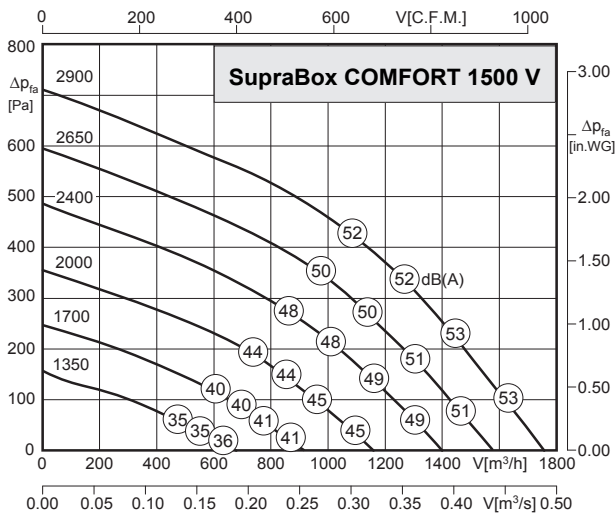

Sound power level:

The sound data represented in the air performance curve is the A-weighted apparent sound power level of the housing L_{WA2} in dB(A).

Pressure side apparent sound power level $LWA5 = LWA2 + 3$ dB

Discharge side apparent sound power level $LWA6 = LWA2 + 25$ dB

Calculation:

$LWA5$ per octave: $LWA5(Ok) = LWA5 +$ correction value (table row $LWA5$)

$LWA6$ per octave: $LWA6(Ok) = LWA6 +$ correction value (table row $LWA6$)

Correction value: ΔL_{Wok} [dB]	f [Hz]						
	125	250	500	1K	2K	4K	8K
$LWA5$ [dB(A)] Pressure side (Outdoor air / Exhaust air)	-15	-12	-4	-5	-8	-15	-29
$LWA6$ [dB(A)] Discharge side (Supply air / Extract air)	-30	-14	-8	-5	-4	-11	-19
$LWA2$ [dB(A)] Noise radiation from the housing	-9	-5	-8	-8	-9	-12	-22

Note: a detailed calculation example can be found on page 40

Dimensions:

All dimensions are in mm. The model in the drawing is shown with supply air connections RIGHT.

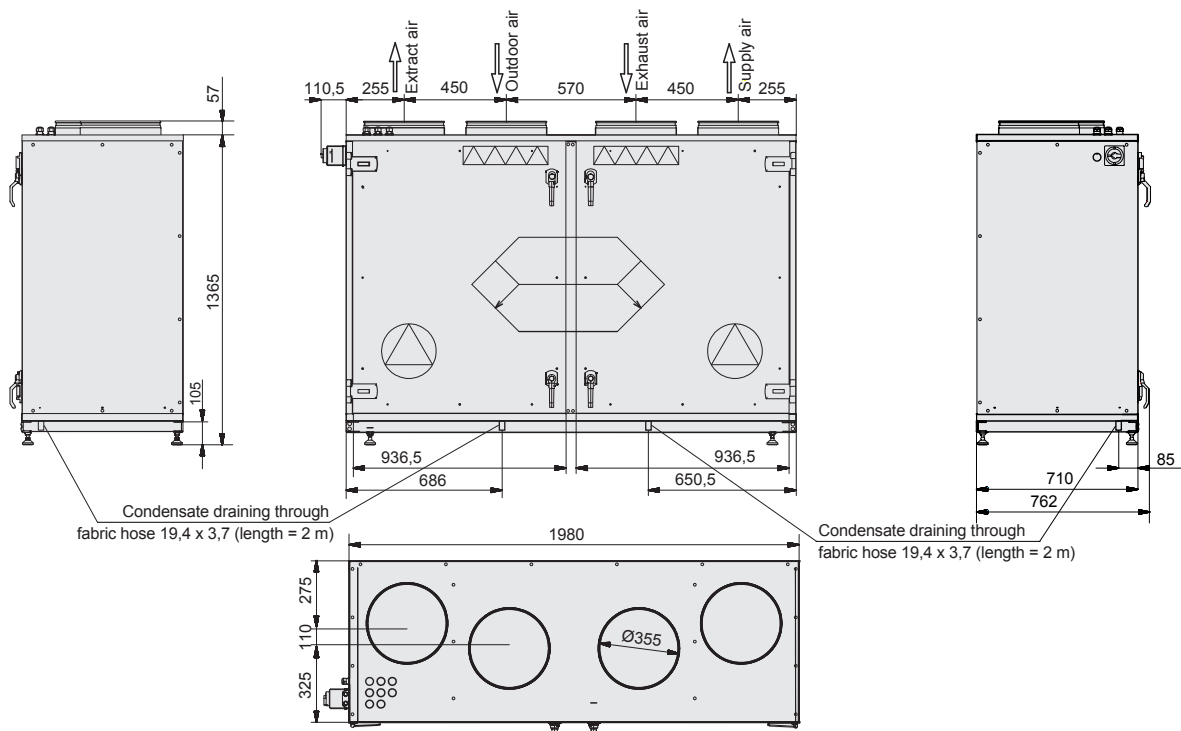

Accessories:

	Flexible Duct (Set of 4)	Page 29		PTC Preheat Coil	Page 33
	Shut-Off Damper (manual / motor driven)	Page 30		Hot Water Pump Reheat Coil	Page 33
	Duct Silencer	Page 29		Cold Water Pump Aftercooler	Page 33
	Electric Reheating Coil	Page 31		Additional electronic accessories (Temperature sensor, CO ₂ -sensor etc.)	Page 28



Standard equipment:

- frameless housing with 60 mm insulation
- coil coated inside and out (RAL 7035)
- conforms to VDI 6022
- integrated control (Plug & Play)
- vertical connections
- energy efficient EC-fans
- high efficiency heat recovery
- 2 service doors; bypass
- interior installation

Technical Specifications: SupraBox 2000 V

Article No. (Anschlussseite)	SB200VGRIB00 (RIGHT)
Dimensions (L x H x T)	2220 x 1510 x 770 mm incl. adjustable feet
Operating Point Air flow volume V_{nenn} ext. pressure increase	2.000 m ³ /h 250 Pa
Fans Voltage Max. power consumption RPM Wattage SFP-class	Free running impeller with backward curved blades, driven by high efficiency EC-external rotor motors with integrated electronics 230 V / 50 Hz 9,5 A 2350 min ⁻¹ 2 x 780 W SFP 3
	
Heat Recovery Efficiency Rating [%]	Cross-flow plate heat exchanger up to 92% *, corresponding to heat recovery class H1 * = maximum value at condensation; efficiency rating is dependent upon operating condition
Air Filter	Panel filter with plastic frame; Supply air: F7 / Return air: M5 (formerly F5) 538 x 608 x 96 mm
Air Connections Diameter Duct Air Speed	vertical ø 400 4,4 m/s
Controller	Supply air / Exhaust air / Room temperature control, Fans steplessly adjustable, Bypass function modulating 0-10V
Bypass	No control damper through the heat recovery, control damper through bypass
Weight incl. controller	430 kg
Max. air flow temperature	40°C (higher air flow temperature available upon request)

Air performance:

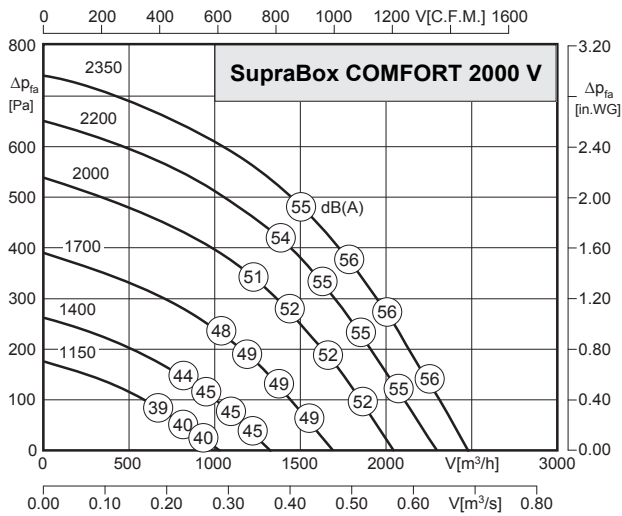

Sound power level:

The sound data represented in the air performance curve is the A-weighted apparent sound power level of the housing L_{WA2} in dB(A).

Pressure side apparent sound power level $LWA5 = LWA2$

Discharge side apparent sound power level $LWA6 = LWA2 + 24 \text{ dB}$

Calculation:

$LWA5$ per octave: $LWA5(Okt) = LWA5 + \text{correction value (table row } LWA5)$

$LWA6$ per octave: $LWA6(Okt) = LWA6 + \text{correction value (table row } LWA6)$

Correction value: ΔL_{Wokt} [dB]	f [Hz]						
	125	250	500	1K	2K	4K	8K
$LWA5$ [dB(A)] Pressure side (Outdoor air / Return air)	-13	-8	-4	-6	-9	-19	-33
$LWA6$ [dB(A)] Discharge side (Supply air / Exhaust air)	-26	-12	-10	-5	-4	-10	-16
$LWA2$ [dB(A)] Noise radiation from the housing	-7	-4	-6	-8	-10	-15	-28

Note: a detailed calculation example can be found on page 40

Dimensions:

All dimensions are in mm. The model in the drawing is shown with supply air connections RIGHT.

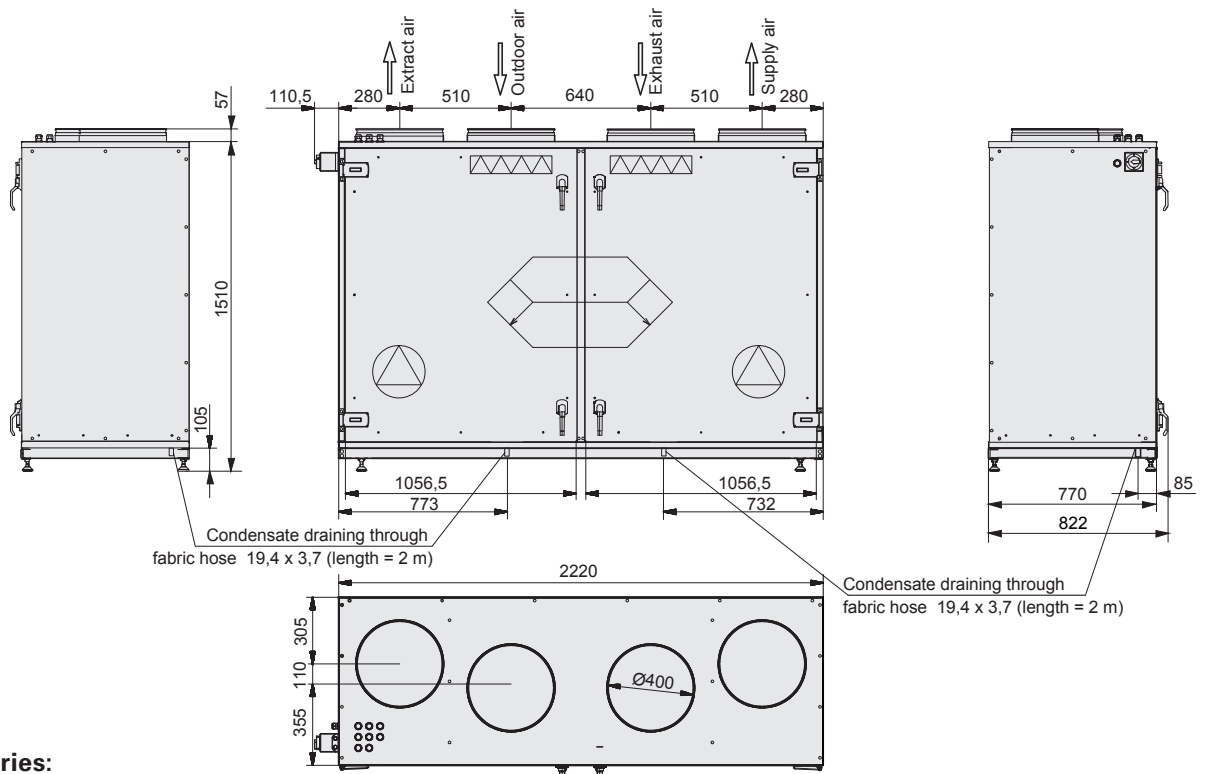

Accessories:

	Flexible Duct (Set of 4)	Page 29		Electronic Preheat Coil	Page 33
	Shut-Off Damper (manual / motor driven)	Page 30		Hot Water Pump Reheat Coil	Page 33
	Duct Silencer	Page 29		Cold Water Pump Aftercooler	Page 33
	Electric Reheating Coil	Page 31		Additional electronic accessories (Temperature sensor, CO2 sensor etc.)	Page 28



Standard equipment:

- frameless housing with 40 mm insulation
- coil coated inside and out (RAL 7035)
- conforms to VDI 6022
- integrated control (Plug & Play)
- horizontal connectors
- energy efficient EC-fans
- high efficiency heat recovery
- 2 service doors; bypass
- interior installation

Technical Specifications: SupraBox 1100 D

<p>Article No. (please note the connection side supply air connections LEFT/RIGHT!)</p>	<p>SB110DGLIB00 (LEFT) ; SB110DGRIB00 (RIGHT)</p>
<p>Dimensions (L x H x T)</p>	<p>1600 x 440 x 1292 mm control box</p>
<p>Operating Point Air flow volume V_{nenn} ext. pressure increase</p>	<p>1.100 m³/h 200 Pa</p>
<p>Fans</p> <p>Voltage Max. power consumption RPM Wattage SFP-class</p> 	<p>Free running impeller with backward curved blades, driven by high efficiency EC-external rotor motors with integrated electronics</p> <p>230 V / 50 Hz 4 A 2600 min⁻¹ 2 x 320 W SFP 2</p>
<p>Heat Recovery Efficiency Rating [%]</p>	<p>Cross-flow plate heat exchanger up to 92% *, corresponding to heat recovery class H1 * = maximum value at condensation; efficiency rating is dependent upon operating condition</p>
<p>Air Filter</p>	<p>Panel filter with plastic frame; Supply air: F7 / Return air: M5 (formerly F5)</p> <p>358 x 553 x 96 mm</p>
<p>Air Connections Diameter Duct Air Speed</p>	<p>horizontal ø 315 3,9 m/s</p>
<p>Controller</p>	<p>Supply air / Exhaust air / Room temperature control, Fans steplessly adjustable, Bypass function modulating 0-10V</p>
<p>Bypass</p>	<p>No control damper through the heat recovery, control damper through bypass</p>
<p>Weight incl. controller</p>	<p>188 kg</p>
<p>Max. air flow temperature</p>	<p>40°C (higher air flow temperature available upon request)</p>

Air performance:

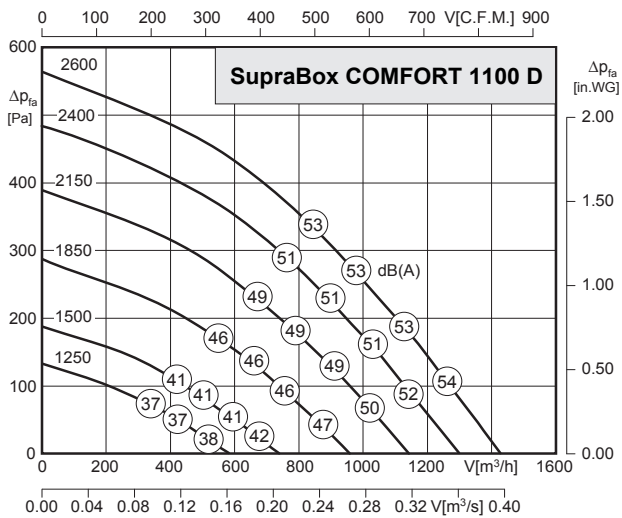

Sound power level:

The sound data represented in the air performance curve is the A-weighted apparent sound power level of the housing L_{WA2} in dB(A).

Pressure side apparent sound power level $LWA5 = LWA2 + 4$ dB

Discharge side apparent sound power level $LWA6 = LWA2 + 24$ dB

Calculation:

$LWA5$ per octave: $LWA5(Okt) = LWA5 +$ correction value (table row $LWA5$)

$LWA6$ per octave: $LWA6(Okt) = LWA6 +$ correction value (table row $LWA6$)

Correction value: ΔL_{Wokt} [dB]	f [Hz]						
	125	250	500	1K	2K	4K	8K
$LWA5$ [dB(A)] Pressure side (Outdoor air / Exhaust air)	-15	-6	-4	-6	-13	-19	-34
$LWA6$ [dB(A)] Discharge side (Supply air / Extract air)	-28	-8	-7	-7	-5	-9	-23
$LWA2$ [dB(A)] Noise radiation from the housing	-6	-9	-3	-13	-15	-18	-23

Note: a detailed calculation example can be found on page 40

Dimensions:

All dimensions are in mm. The model in the drawing is shown with supply air connections LEFT. The model with supply air connections RIGHT is vertically mirrored. For installation of the system a height of 460 mm is required (Angle construction height 4 mm, Fastening 3 mm, 6 KT screw 7 mm).

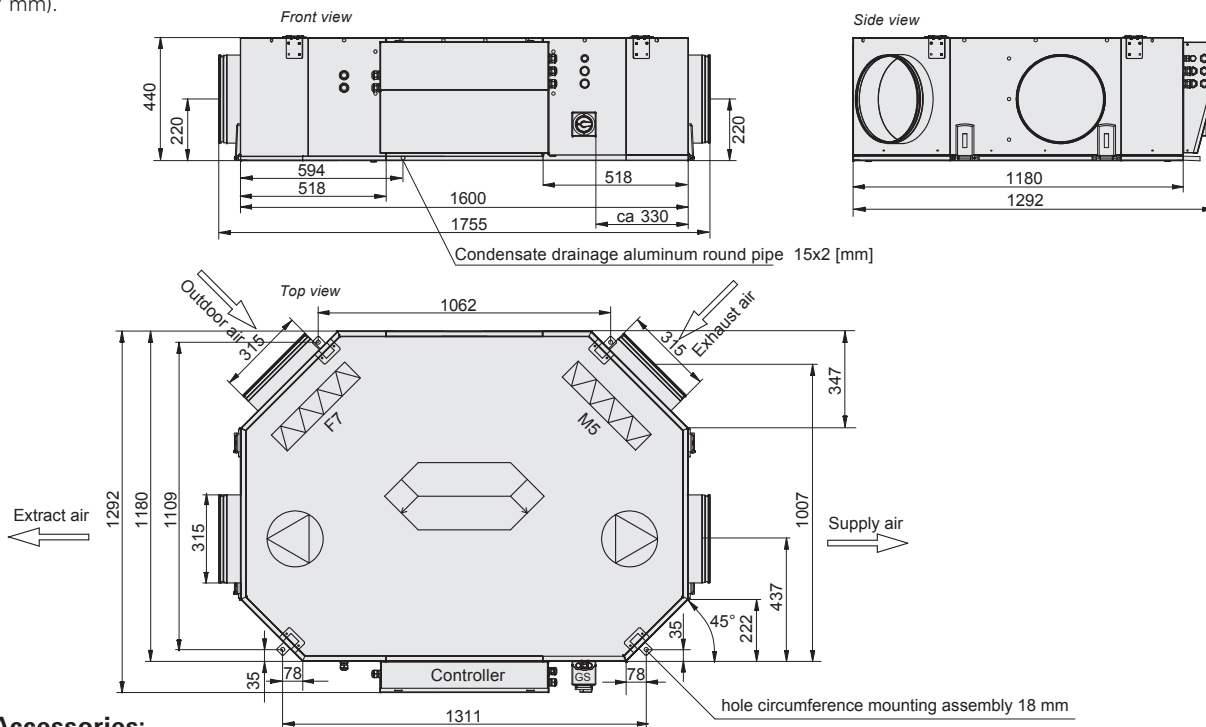

Accessories:

	Flexible Duct (Set of 4)	Page 29		PTC-Preheat Coil	Page 32
	Shut-Off Damper (manual / motor driven)	Page 30		Hot Water Pump Reheat Coil	Page 33
	Duct Silencer	Page 29		Cold Water Pump Aftercooler	Page 33
	Electric Reheating Coil	Page 31		Additional electronic accessories (Temperature sensor, CO2 sensor etc.)	Page 28



Standard equipment:

- frameless housing with 40 mm insulation
- coil coated inside and out (RAL 7035)
- conforms to VDI 6022
- integrated control (Plug & Play)
- horizontal connectors
- energy efficient EC-fans
- high efficiency heat recovery
- 2 service doors; bypass
- interior installation

Technical Specifications: SupraBox 1900 D

<p>Part Number (please note the connection side supply air connections LEFT/RIGHT!)</p>	<p>SB190DGLIB00 (LEFT) ; SB190DGRIB00 (RIGHT)</p>
<p>Dimensions (L x H x T)</p>	<p>1600 x 440 x 1892 mm control box</p>
<p>Operating Point Air flow volume V_{nenn} ext. pressure increase</p>	<p>1.900 m³/h 250 Pa</p>
<p>Fans</p> <p>Voltage Max. power consumption RPM Wattage SFP-class</p> 	<p>Free running impeller with backward curved blades, driven by high efficiency EC-external rotor motors with integrated electronics</p> <p>230 V / 50 Hz 9 A 2800 min⁻¹ 2 x 750 W SFP 3</p>
<p>Heat Recovery Efficiency Rating [%]</p>	<p>Cross-flow plate heat exchanger up to 92% *, corresponding to heat recovery class H1 * = maximum value at condensation; efficiency rating is dependent upon operating condition</p>
<p>Air Filter</p>	<p>Panel filter with plastic frame; Supply air: F7 / Exhaust air: M5 (formerly F5)</p> <p>358 x 848 x 96 mm</p>
<p>Air Connections Diameter Duct Air Speed</p>	<p>horizontal 330 x 480 mm 3,3 m/s</p>
<p>Controller</p>	<p>Supply air / Exhaust air / Room temperature control, Fans steplessly adjustable, Bypass function modulating 0-10V</p>
<p>Bypass</p>	<p>No control damper through the heat recovery, control damper through bypass</p>
<p>Weight incl. controller</p>	<p>270 kg</p>
<p>Max. air flow temperature</p>	<p>40°C (higher air flow temperature available upon request)</p>

Air performance:

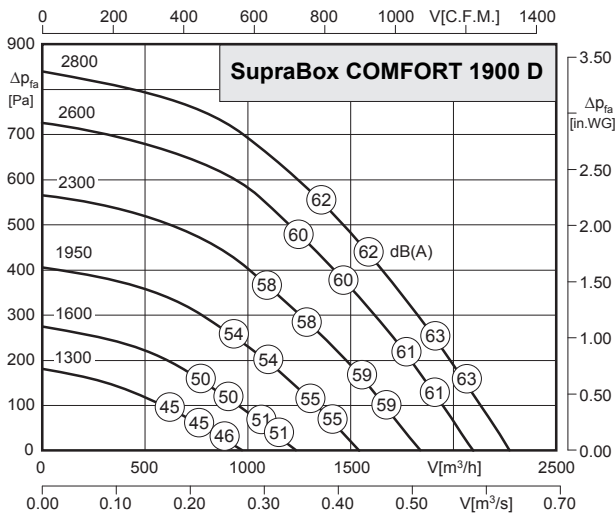

Sound power level:

The sound data represented in the air performance curve is the A-weighted apparent sound power level of the housing L_{WA2} in dB(A).

Pressure side apparent sound power level $LWA5 = LWA2 + 1$ dB

Discharge side apparent sound power level $LWA6 = LWA2 + 24$ dB

Calculation:

$LWA5$ per octave: $LWA5(Oct) = LWA5 +$ correction value (table row $LWA5$)

$LWA6$ per octave: $LWA6(Oct) = LWA6 +$ correction value (table row $LWA6$)

Correction value: ΔL_{Woct} [dB]	f [Hz]						
	125	250	500	1K	2K	4K	8K
$LWA5$ [dB(A)] Pressure side (Outdoor air / Exhaust air)	-12	-10	-6	-3	-11	-22	-41
$LWA6$ [dB(A)] Discharge side (Supply air / Extract air)	-14	-11	-6	-5	-6	-11	-19
$LWA2$ [dB(A)] Noise radiation from the housing	-19	-6	-3	-7	-16	-20	-36

Note: a detailed calculation example can be found on page 40

Dimensions:

All dimensions are in mm. The model in the drawing is shown with supply air connections LEFT. The model with supply air connections RIGHT is vertically mirrored. For installation of the system a height of 460 mm is required (Angle construction height 4 mm, Fastening 3 mm, 6 KT screw 7 mm).

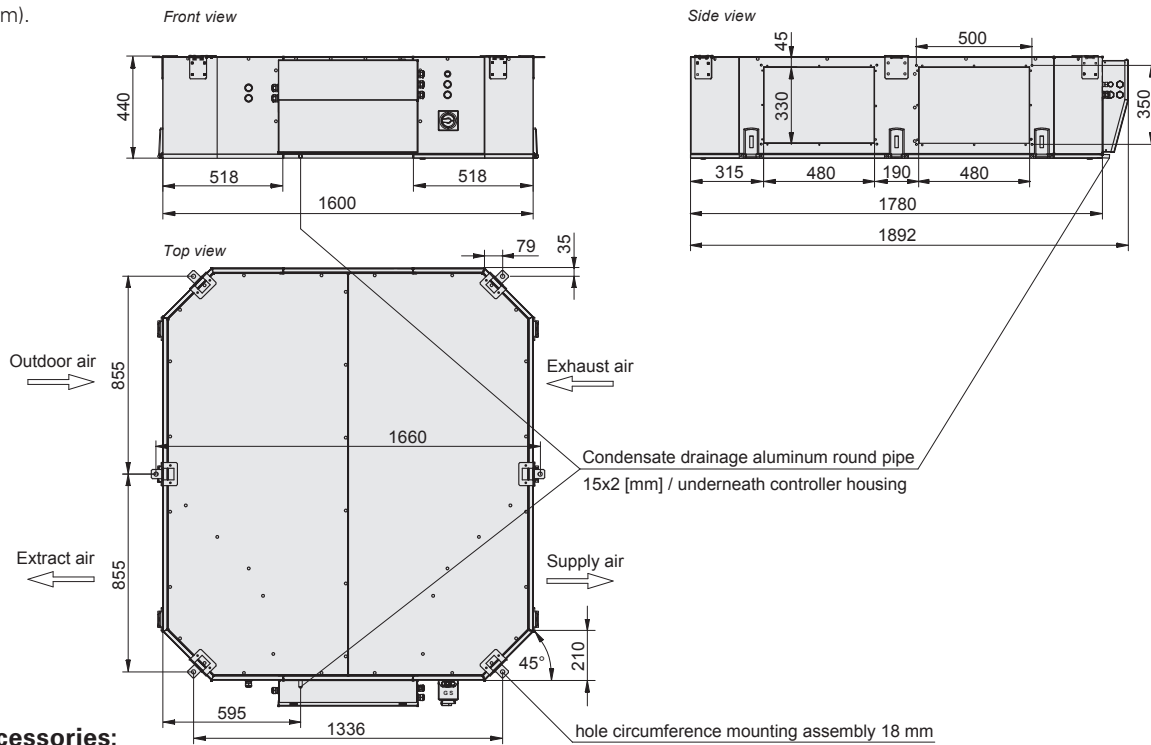

Accessories:

	Flexible Duct (Set of 4)	Page 29		Electronic Preheat Coil	Page 33
	Shut-Off Damper (motor driven)	Page 30		Hot Water Pump Reheat Coil / Cold Water Pump Aftercooler	Page 33
	Duct Silencer	Page 29		Transition piece square to round	Page 30
	Electric Reheating Coil	Page 31		Additional electronic accessories (Temperature sensor, CO2 sensor etc.)	Page 28

Controller for the SupraBox Comfort

The controllers were designed specifically for the operation of the compact ventilation units SupraBox Comfort with optimum safety and ease of use in mind for operation, monitoring and servicing of the system. The most modern DDC-technology is utilized.



Functions and Properties

- Settings are easily entered using the control panel
- Built-in weekly and yearly clock
- Various control functions can subsequently be activated
- The controls are mounted with horizontal ducts on the top (integrated in the 3500H) and, for units designed for ceiling mounting, on the side. For vertical air flow the controls are integrated in the unit.
- Temperature control can be selected according to room temperature (with additional sensors), supply air or return air
- 3 different user levels are available (daily user, service technician, initial setup)
- 10m connection cable (loose) for the control panel is included
- Menu in German or English

Note:

All settings can be adjusted for one of the three user levels. Only the fan speed, the set point temperature, the clock with the weekly program and the menu languages can be adjusted without entering a password. This assures the day-to-day user-friendly and clear operation. When using additional

accessories for thermal air handling, the option exists to connect suitable safety sensors to the control panel:

- Contact thermostat for hot water coils
- Alarm input for electronic heater coils
- Optional contact thermostat sensor for hot water coils

Control schematics:

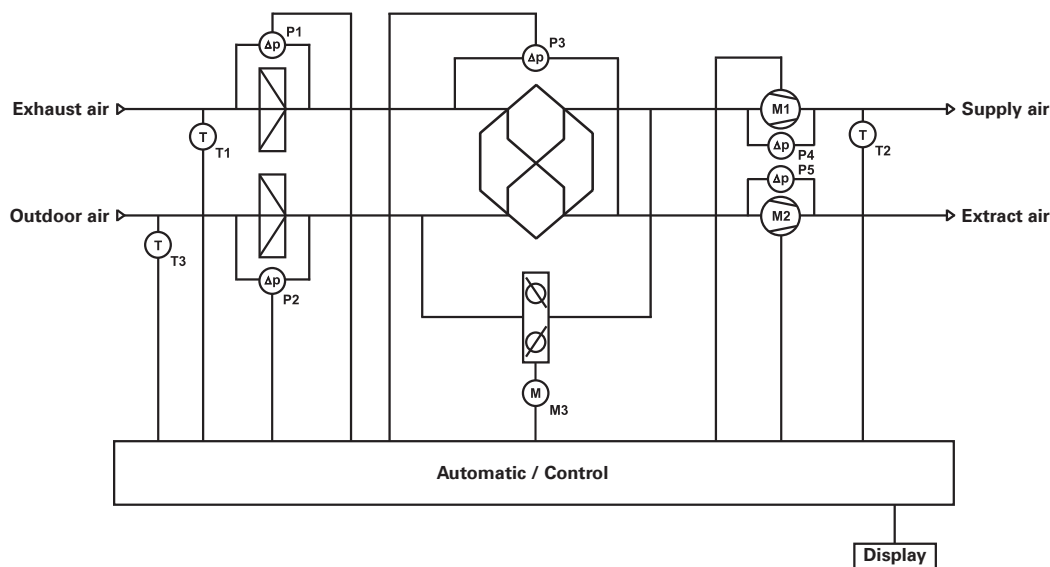

T1 Exhaust air sensor	M1 Motor-Supply air fan	P1 Filter Pressure Sensor Exhaust Air	P4 Supply air fan pressure sensor to calculate air flow
T2 Supply air sensor	M2 Motor-Extract air fan	P2 Filter Pressure Sensor Outdoor Air	P5 Extract air fan pressure sensor to calculate air flow
T3 Outdoor air sensor	M3 Bypass damper actuator	P3 Heat Recovery Pressure Can Freezing	

Overview of the Control Functions

All control functions shown in the table on the following page are available in the program as standard (always available). In order to use certain individual functions it might be

necessary to connect the corresponding accessory (accessory required) and/or to set or enable the functions at the control panel (enable required).

Overview of the Control Functions				
Function	Description	Always available	Input required	Accessory required
Filter Monitor	Constant pressure sensors for monitoring the pressure drop across the filter – if the pressure drop crosses the set threshold an alarm will be displayed	●		
Bypass	During constant bypass of the supply air the heat recovery is adjusted so that the supply air temperature is maintained	●		
Temperature Sensors	In the exhaust air pipe end to measure the return air temperature	●		
	In the outdoor air pipe end to measure the outdoor air temperature	●		
	In the supply air pipe end to measure the supply air temperature	●		
	Duct temperature sensor			● (Temperature Sensor)
	Room temperature sensor			● (Temperature Sensor)
	Outdoor temperature sensor			● (Temperature Sensor)
Motor Protection	An alarm will be tripped when there is danger of overheating and the system will be shut off	●		● (Damper w/actuator)
Smoke Detector	Smoke detector, fire sensor, or fire alarm connected by to an alarm monitoring service	●		
Shut-Off Damper Outdoor Air	The damper installed in the outdoor air duct closes when system shuts off – 24V available with or without return spring		●	● (Damper w/actuator)
Shut-Off Damper Extract Air	The damper installed in the extract air duct closes when system shuts off - 24V available with or without return spring		●	● (Damper w/actuator)
Temperature Control	Control of the supply air temperature		●	
	Control of the room temperature		●	● (Temperature Sensor)
	Control of the exhaust air temperature		●	
Fan Control	Air volume control		●	
	RPM control		●	
	Pressure Control		●	● (Pressure Sensor)
	Controlled on demand depending on temperature		●	
	Controlled on demand with 0-10 V		●	● (Sensor or GLT)
Control Panel	Control Panel with user, service and technician level	●		
Timer	Weekly clock for setting the desired switch points with adjustments for temperature and fan		●	
	Yearly clock for setting the desired switch points with adjustments for temperature and fan		●	
Cooler control	Control signal to an external cooler unit (230 V Enable as well as 0-10 V)		●	● (Cold Water Pump Cooler)
Cold air recovery	When conditions exist where room air is cooler than outdoor air then the bypass stays closed in summer	●		
Frost prevention	Pressure sensors to monitor the pressure drop using heat recovery – if the pressure drop exceeds the set limit the frost prevention process will be stopped	●	●	
Alarm Relay	Collective fault signal for external alarm	●		
Overheating Control	Control signal for external warm water pump baffle (230 V Enable as well as 0-10 V)		●	● (Heater Warm Water Pump)
	Control signal for external electric heater (0-10 V)		●	● (External electric heater)
External Shut-off	Input for external, floating contact for ON/OFF	●		● (external switch contact)
Party function	Overdrive of the fans by external, floating contact	●		● (external switch contact)
Backup Mode	When room temperature control is set the backup mode prevents an overcooling or overheating of the controlled room		●	● (Room temperature sensor)
Night ventilation	In summer when temperatures permit the room will be cooled by cold outdoor air		●	● (Room temperature sensor)
Pre-heating	Enable signal for single speed electronic pre-heating radiator		●	● (Pre-heating)
Communication	Integration into a Modbus RTU network as slave			● (Modbus Plugin)

System Temperature Sensor (P/N.: H42-09917)

If a return air temperature is to be used, a contact temperature sensor is required. This will be attached at the return of the warm water radiator just like the contact thermostat.



Hygrostat (P/N.: H42-09922)

The hygrostat can be used to overdrive the fans, so that when the set limit is reached the ventilation will automatically be switched over.



RS 485 Interface (P/N.: H42-00330)

The RS 485 interface for Modbus RTU is a plugin that can be attached directly to the main board in order to integrate the SupraBox control as slave in a Modbus network.



Dual Differential Pressure Sensor

(P/N.: H40-12500) with Modbus connection to be used with constant pressure control of the fans.



Duct Sensors (P/N.: H42-09926)

Since the SupraBox is already equipped with temperature sensors in the pipe ends, additional duct sensors are recommended. Specifically when using heat exchangers (for ex. Heating Coil, Cooling Coil), If a Heating or Cooling Coil is used from Rosenberg, a corresponding duct sensor is already included in the scope of delivery.

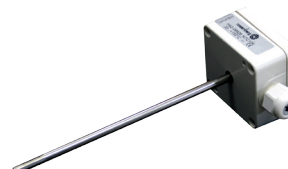

Room Temperature Sensor (P/N.: H42-09902)

The room temperature sensor is suited for wall mounting. Leitung, here the polarity also has no influence on the measurement. The use of the room temperature sensor is prerequisite for room temperature control as well as the back-up mode and night ventilation function.



Outdoor Air Temperature Sensor (P/N.: H42-09914)

The outdoor air temperature sensor is suited for wall mounting. The use of the room temperature sensor is prerequisite for the night ventilation function.



CO₂ Sensor (P/N.: H42-09933)

The CO₂ Sensor can be used in automatic operation to control the fans to keep the CO₂ levels in the room low.



Duct Silencer

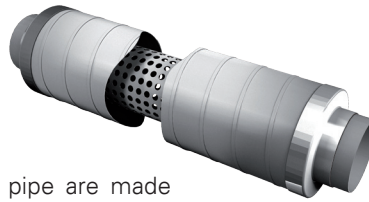

Properties and constructions:

The outside cover and the perforated inner pipe are made from galvanized steel. The sound dampening package is 50 mm strong. The pipe end connections with lip seals can be directly integrated in the pipe system.

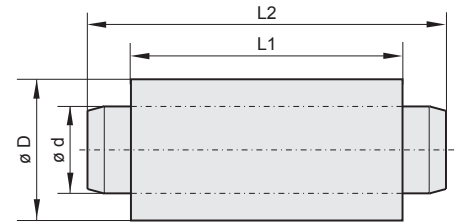

Art.-Nr.	Ød	ØD	L1	L2	Damping Values in dB							
					125 Hz	250 Hz	500 Hz	1 kHz	2 kHz	4 kHz	8 kHz	
SupraBox 800 V												
F13-25000	DN 250	365	1070	1170	4	11	17	23	26	23	20	
SupraBox 800 H / 1100 V / 1100 D												
F13-31500	DN 315	410	1070	1170	4	9	17	22	24	18	16	
SupraBox 1100 H / 1500 V / 1900 D*												
F13-35500	DN 355	460	1060	1160	4	8	15	21	20	17	16	
SupraBox 1500 H / 2000 H / 2000 V / 1900 D*												
F13-40000	DN 400	510	1060	1160	3	8	14	19	21	15	14	

* **Note:** Categorization depends upon operating point and air speed of the system, as transition piece from square to round might be required!

Flexibler Stutzen

Properties and constructions

- complete set consisting of 4 pieces
- made from galvanized steel and silicon-free PVC-fabric to isolate the SupraBox to the duct system
- fitting connections for commercially available spiral ducts
- T-lip seal for quack and tight connections
- includes 2 hose clamps per pipe end



SupraBox	Art.-Nr.	Ø	Installation Length
800 V	ELSS00-0250S	DN 250	260 mm
800 H / 1100 V / 1100 D	ELSS00-0315S	DN 315	160 mm
1100 H / 1500 V	ELSS00-0355S	DN 355	160 mm
1500 H / 2000 H / 2000 V	ELSS00-0400S	DN 400	160 mm

- complete set consisting of 4 pieces
- consisting of two frames (20 mm) made from galvanized steel plate and a fabric band made from PVC-coated polyester installed in-between
- for SupraBox 1900 D with square connection



SupraBox	Art.-Nr.	Dimensions	Measurement	Overall Length
1900 D	ELSS00-0330S	478 x 328 mm	130 mm	140 mm

Shut-Off Damper (manual or motor driven)

Properties and constructions:

Manual drive:

- tight sealing, tightness category 4 behind closed baffle
- Damper made of double layer sheet metal with gasket in between layers made of EPDM rubber, that when closed rests against lid casing

Motor driven:

- tight sealing, tightness category 4 behind closed flap
- construction like the shut-off damper manual drive, however with console for motor drive incl. appropriate servo motor
- function open/close, voltage 24V, without return spring (with return spring available on request)
- square version for SupraBox 1900 D (tightness category 2)

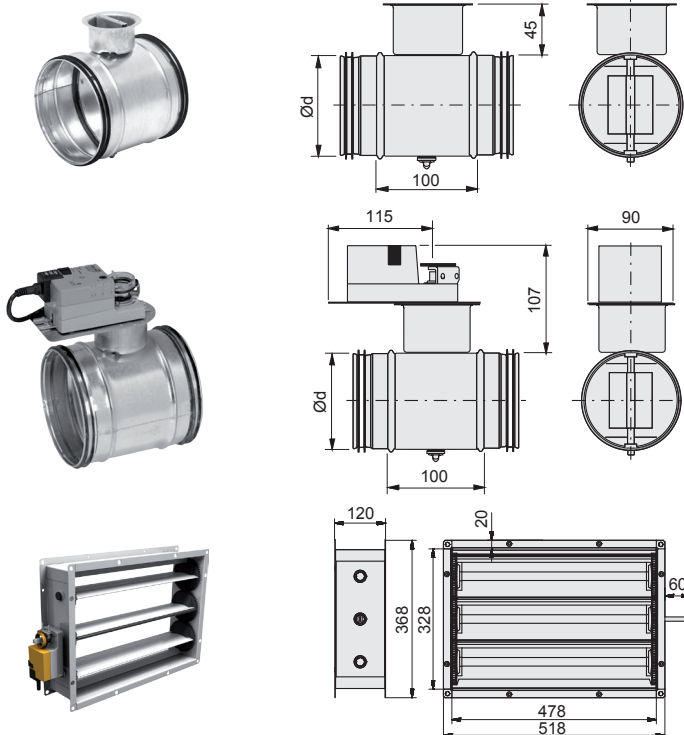

SupraBox	Ø d	Motor driven	Manually driven
800 V	250	ASK001-0250N	ASK001-0250H
800 H / 1100 V / 1100 D	315	ASK001-0315N	ASK001-0315H
1100 H / 1500 V	355	ASK001-0355N	ASK001-0355H
1500 H / 2000 H / 2000 V	400	ASK001-0400N	ASK001-0400H
1900 D*	-	ASK000-0330N	-

* **Note:** The shut-off Damper can be attached to the housing simply with M8 screws. The potentially necessary transition to the round pipe can then follow.

Transition piece square to round (only SupraBox 1900 D)

Properties and constructions:

- Transition piece made of galvanized steel sheet
- for SupraBox 1900 D optionally to DN 355 or DN 400
- T-double lip seal for tight connections

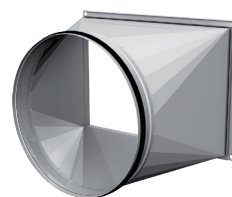

Schematic connection diagram:

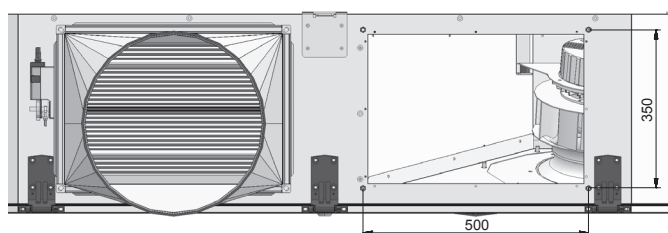

Dimensions:

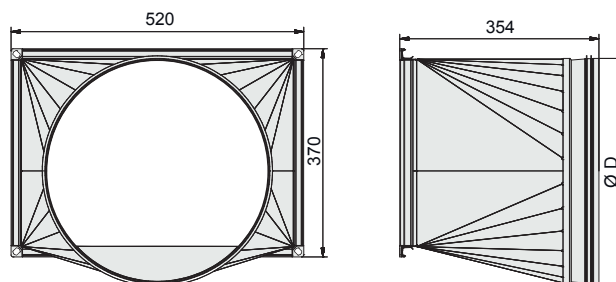

SupraBox	Art.-Nr.	Transition to: øD
1900 D	I21-33481	355
1900 D	I21-33482	400

Electric Reheating Coil

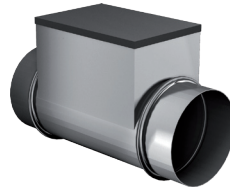

- Installation kit consisting of electric heater and duct temperature sensor
- Electric heating coil in a round pipe made from galvanized steel plate with dual sided rubber lip seal
- Pipe heating elements made from stainless steel EN 1.4541
- Coil is rated IP43
- air tightness class C according to EN 1751
- min. air speed in the connection cross section is 1.5 m/s
- maximum exhaust air temperature + 40°C
- ambient temperature max. 30°C
- integrated continuous electronic control with thyristor, allowing performance control of 0-100%
- control of the electronics through the SupraBox via 0...10V
- connection to the power supply directly at the coil, fuse protection (on site) 16A
- double overheating protection with a self-resetting temperature monitor and a safety temperature limiter with manual resetting
- integrated electronic air flow monitor
- the air side pressure drop is very small (just a few Pascal)!

All electronic heating coils are made exclusively for installation indoors!

Electric Reheating Coil					
Electric Reheater Art.-Nr.	Connection diameter	Maximum performance	Voltage	Length	Minimum-Air flow (1.5 m/s)
SupraBox 800 V					
G95-25027	DN 250	2,7 kW	1~ 230V	375 mm	270 m³/h
G95-25050		5,0 kW	2~ 400V	375 mm	
SupraBox 800 H / 1100 V / 1100 D					
G95-31527	DN 315	2,7 kW	1~ 230V	375 mm	430 m³/h
G95-31550		5,0 kW	2~ 400V	375 mm	
SupraBox 1100 H / 1500 V / 1900 D*					
G95-35530	DN355	3,0 kW	1~ 230V	375 mm	540 m³/h
G95-35550		5,0 kW	2~ 400V	375 mm	
G95-35590		9,0 kW	3~ 400V	375 mm	
SupraBox 1500 H / 2000 H / 2000 V / 1900 D*					
G95-40090	DN400	9,0 kW	3~ 400V	375 mm	680 m³/h

* **Note:** Categorization depends upon operating point and air speed of the system, a transition piece from square to round might be required!

Possible temperature increase at capacity rating for electric pre- and reheater:

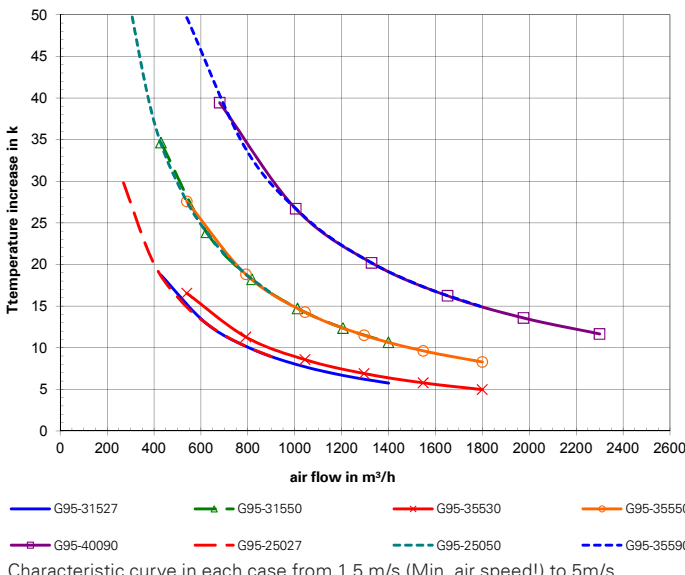

Characteristic curve in each case from 1.5 m/s (Min. air speed!) to 5m/s

Important Installation Notes:

As long as the minimum air flow is maintained, a SupraBox model size can be dedicated to the heating coil of another model size. For example a G95-35530 for the SupraBox 1500 H, which is actually intended for the SupraBox 1100 H. On the construction side one needs to use the appropriate reducing piece for installing it to the duct system.

Einbauhinweis zum Kanaltemperaturfühler:

Installation Note for the duct temperature sensor: In order for the duct temperature sensor to be unaffected by the heat radiated from the heating coil, it needs to be installed after the electric heater coil with the min. distance for 2-3 m in the supply air duct.

Preheating to prevent freezing / and for defrosting of the heat recovery

If a preheater is need for antifreeze protection depends on the following:

- the winter layout-outdoor temperature
- the return air humidity
- the return air temperature
- the freeze prevention option selected at the controller of the SupraBox (see page 3)

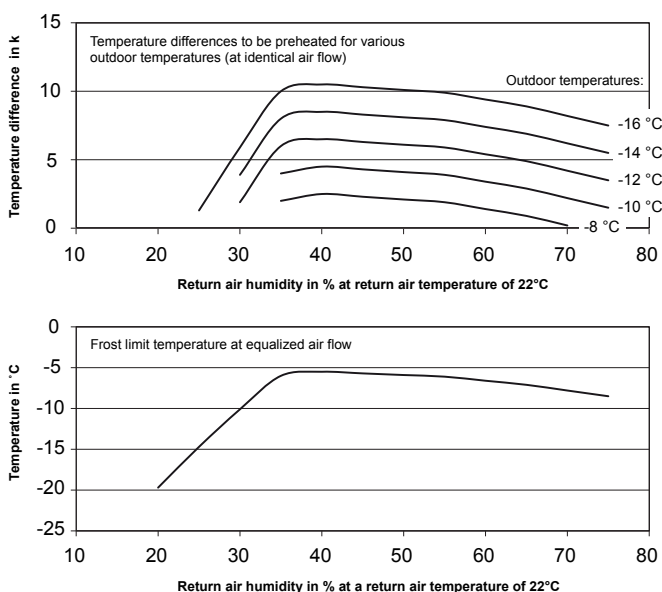

If considerable humidification of the return air through people or other loads is not expected and if reductions in other functions like reducing the air flow or even temporary shut-off during the few coldest hours of the year, then one can do without preheating!

If preheating is desired, then the accompanied drawing shows the temperature differences to be preheated dependent upon the outdoor temperature and return air humidity. All SupraBox-Versions behave the same in this regard. For preheating we offer various different electric preheating coils that will make the operation of the SupraBox safer in winter in the majority of Central Europe. In the drawing on the left you will find the temperature increases that can be achieved with the preheating coils. All preheating coils are single step non-controlled and will be turned off by the SupraBox controller when necessary, see the chapter on Control. The air side pressure drop of the preheating coil is very low (only a few Pascall)

The preheating coils are also intended exclusively for installation in buildings!

SupraBox 800 to 1100: PTC-Electronic Preheater

For the SupraBox-Sizes 800 and 1100 we offer a preheating and installation kit with PTC-heating coils (IP00) for installation in outdoor air connection ends and an additional duct temperature sensor for installation in the outdoor air duct. Through an array of sheet metal plates the adaptation to various sizes can be accomplished. In contrast to other electronic heating coils the wiring of the PTC takes place entirely at the Supra Box. The PTC is a thermistor, which will reduce its power consumption as it heats up. Through an additional integrated temperature monitor the PTC-element will shut off when air temperature directly at the exhaust pass 80°C and will turn on again when temperature drop. Since the PTC only covers part of the connection pipe end so that the large majority of the air passes by the PTC



without a temperature increase, one obtains a mixed temperature after the PTC. At the same time, the operation with bypass at the PTC ensures minimal pressure loss. Due the properties of the PTC its heating performance cannot be precisely determined. When turning on the power can briefly reach up to 16A and then drops drastically. In the outdoor air connection pipe end of the SupraBox the heating performance varies, especially dependent upon the air speed in the duct and additionally dependent on the incoming air temperature. The diagram „Temperature Increase Preheater“ on the following page shows approximately the attainable temperature increases. It is recommended to build in the possibility to clean the PTC-heater coil or prefilter respectively.

Art.-Nr.	Connection diameter	Rated capacity	Voltage	Length	Min. Air flow (1.5 m/s)
SupraBox 800 V					
G92-25PTC	DN 250	2,4 kW	1~ 230V	-	-
SupraBox 800 H / 1100 V / 1100 D					
G92-31PTC	DN 315	2,4 kW	1~ 230V	-	-
SupraBox 1100 H					
G92-35PTC	DN 355	2,4 kW	1~ 230V	-	-

SupraBox 1500 / 1900 / 2000: Electric Preheater

Installation Kit consisting of electronic heater and electronic air flow monitor. Coil similar to the electronic reheaters, how-

ever without performance control through a thyristor, rather the coil is turned on and off by an integrated contactor.

Art.-Nr.	Connection diameter	Overall Performance	Voltage	Length	Min. Air flow (1.5 m/s)
SupraBox 1500 V / 1900 D*					
G96-35560	DN355	6,0 kW	2~ 400V	355 mm	540 m³/h
SupraBox 1500 H / 2000 H / 2000 V / 1900 D*					
G96-40060	DN400	6,0 kW	2~ 400V	400 mm	680 m³/h

* **Note:** Categorization depends upon operating point and air speed of the system, a transition piece from square to round might be required!

Temperature Increase Preheater:

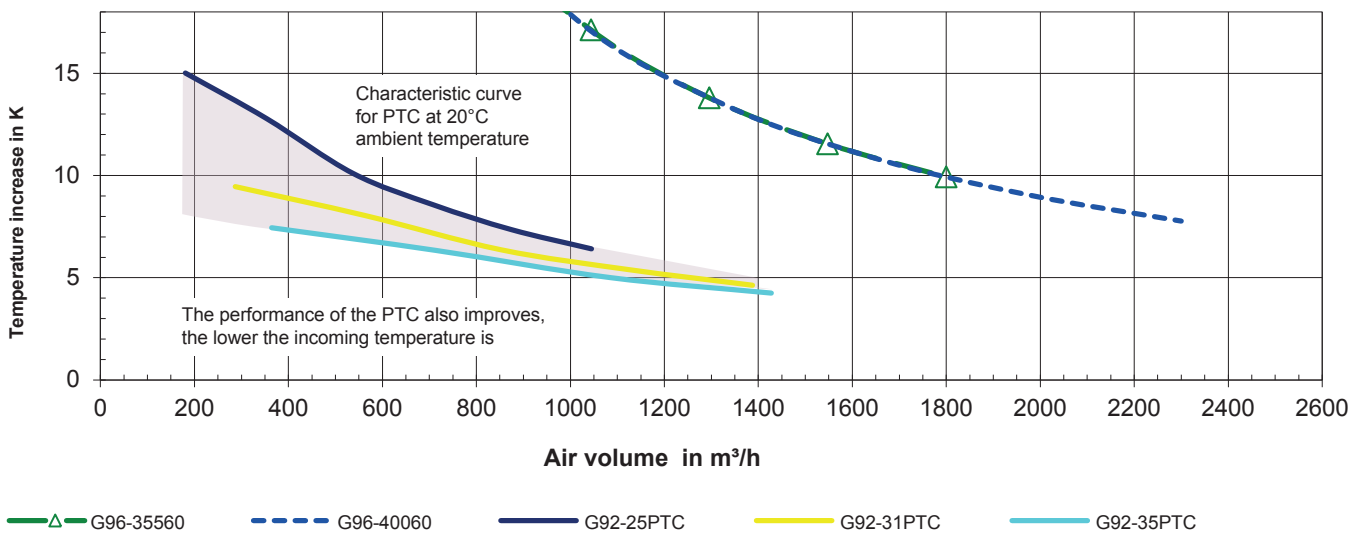

Reheating Coil and Re und Aftercooler

Hot water and cold water pump – Coil for duct installation

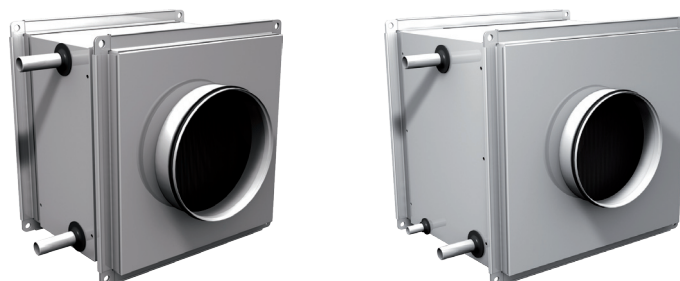

- Complete installation kit including 3 way valve with hardware, actuator and duct temperature sensor
- Coil with 3/8" copper pipes and collectors, aluminum fins with 0.2 mm
- With 30 mm flange all the way around and attached transition pieces (galvanized steel) from square to round with lip seal

- Since the ceiling mounted unit SupraBox 1900 D has square connections and us wanting to give you the possibility for various ceiling installations with varriing availability of space we supply the coil for the SupraBox 1900 D without transition pieces square to round.

Hot water pump – Reheater / Cold water pump – Aftercooler

Characteristics of the hot water pump reheater:

- Frame galvanized steel
- Fin spacing 2,0 mm, conforms to DIN EN 13053
- Frost prevention thermostat is already installed on the coil frame

Characteristics of the cold water pump - aftercooler

- Frame galvanized steel
- Condensate tub aluminum AlMg3, Condensate drain 1/2" Horizontally in connection direction of the coils
- Fin spacing 2,5 mm, conforms to DIN EN 13053
- integrated demister

Heater:

Cooler:

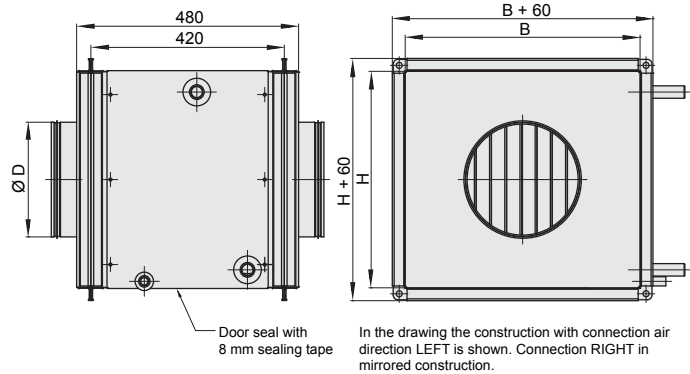
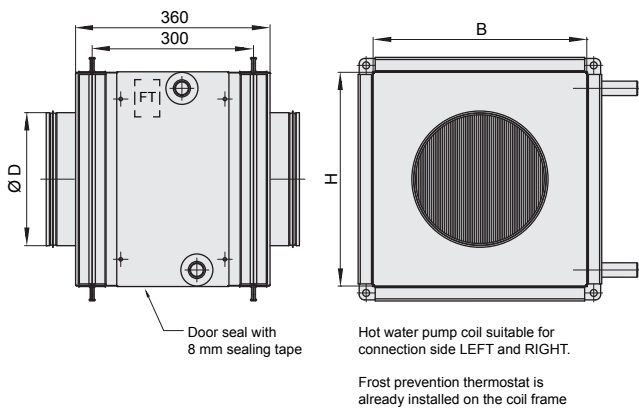

Hot water pump – Reheater					
Art.-Nr.	Number of pipe rows	B [mm]	H [mm]	ø Pipe connection	ø D [mm]
SupraBox 800 V					
(Set 1) G90-4642252L	2	460	416	G 1/2"	DN 250
(Set 2) G90-4642254L	4				
SupraBox 800 H / 1100 D					
(Set 1) G90-4642312L	2	460	416	G 1/2"	DN 315
(Set 2) G90-4642314L	4				
SupraBox 1100 V					
(Set 1) G90-5147312L	2	510	466	G 1/2"	DN 315
(Set 2) G90-5147314L	4				
SupraBox 1100 H					
(Set 1) G90-5147352L	2	510	466	G 1/2"	DN 355
(Set 2) G90-5147354L	4				
SupraBox 1500 V					
(Set 1) G90-6157352L	2	610	566	G 1/2"	DN 355
(Set 2) G90-6157354L	4				
SupraBox 1500 H / 2000 H / 2000V					
(Set 1) G90-6157402L	2	610	566	G 1/2"	DN 400
(Set 1) G90-6157404L	4				
SupraBox 1900 D (Coil without transitions)					
(Set 1) G90-9139002L	2	910	392	G 1/2"	-
(Set 2) G90-9139004L	4				

Hot water pump – Reheater						
Art.-Nr. Connection side LEFT	Art.-Nr. Connection side RIGHT	Number of Pipe Rows	B [mm]	H [mm]	ø Pipe con- nection	ø D [mm]
SupraBox 800 V						
G91-4642255L	G91-4642255R	5	460	416	G 1/2"	DN 250
SupraBox 800 H / 1100 D						
G91-4642315L	G91-4642315R	5	460	416	G 1/2"	DN 315
SupraBox 1100 V						
G91-5147316L	G91-5147316R	6	510	466	G 3/4"	DN 315
SupraBox 1100 H						
G91-5147356L	G91-5147356R	6	510	466	G 3/4"	DN 355
SupraBox 1500 V						
G91-6157356L	G91-6157356R	6	610	566	G 1"	DN 355
SupraBox 1500 H / 2000 H / 2000 V						
G91-6157406L	G91-6157406L	6	610	566	G 1"	DN 400
SupraBox 1900 D (Coil without transitions)						
G91-9139006L	G91-9139006L	6	910	392	G 1"	-

Hot Water Pump Reheat SupraBox 800 V / 800 H / 1100 D

Ancillary conditions of the selection diagrams: air entry temperature at coil 12°C, air density 1,2 kg/m³, medium water, spread 20K

Maximum heat output

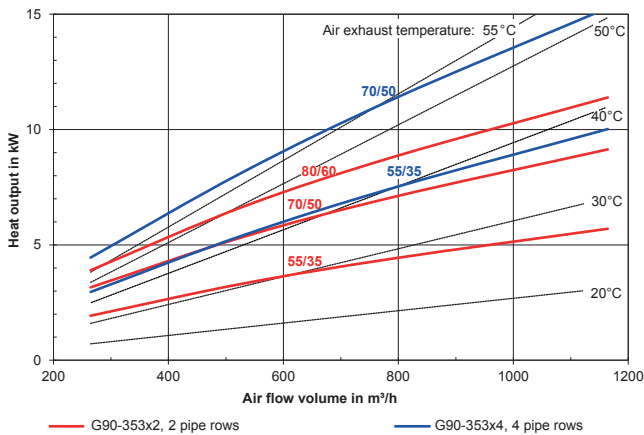

Air side pressure loss

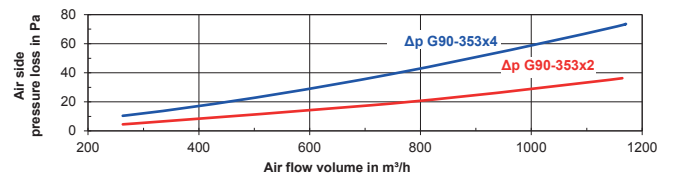

Water flow volume und water side pressure loss

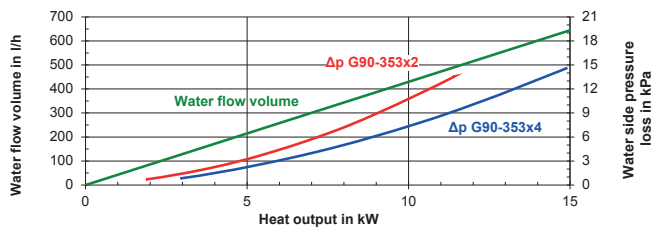

Hot Water Pump Reheater SupraBox 1100 V / 1100 H

Ancillary conditions of the selection diagrams: air entry temperature at coil 12°C, air density 1,2 kg/m³, medium water, spread 20K

Maximum heat output

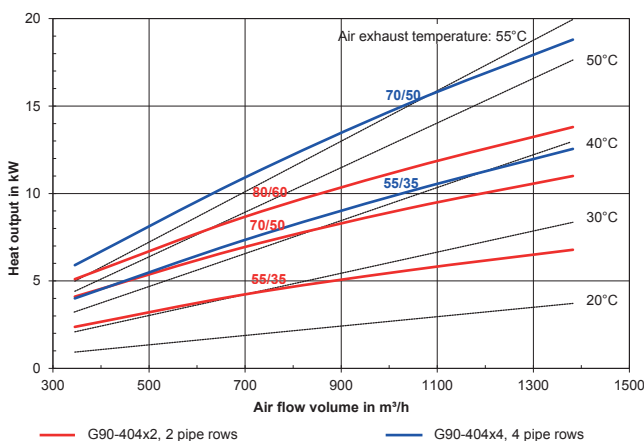

Air side pressure loss

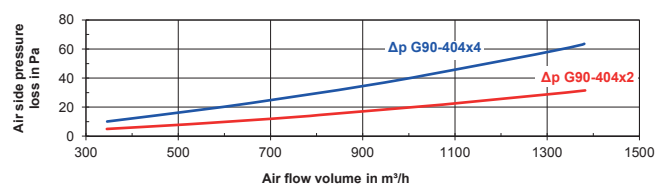

Water flow volume und water side pressure loss

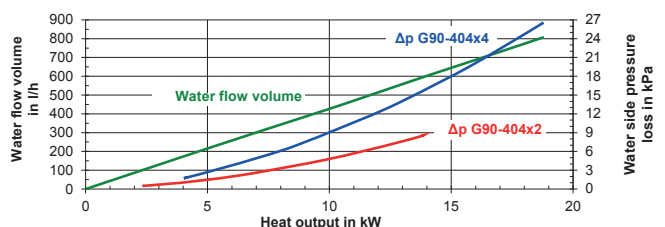

Hot Water Pump Reheater SupraBox 1500 V / 1500 H / 2000 V / 2000 H

Ancillary conditions of the selection diagrams: air entry temperature at coil 12°C, air density 1,2 kg/m³, medium water, spread 20K

Maximum heat output

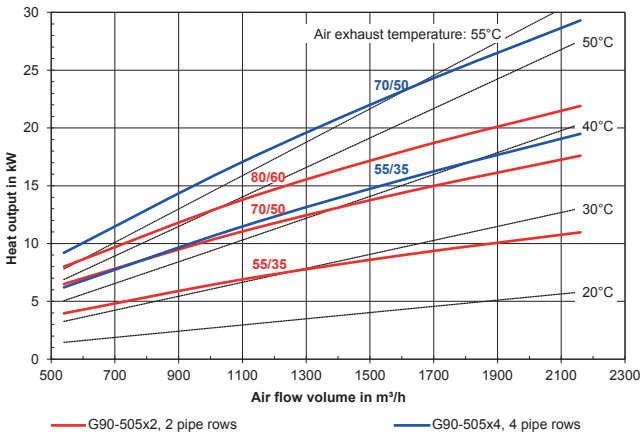

Air side pressure loss

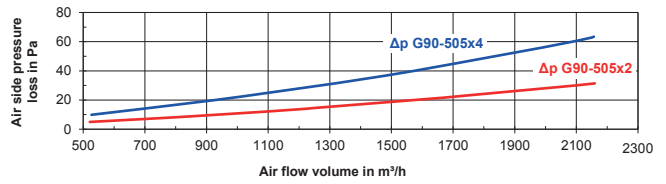

Water flow volume und water side pressure loss

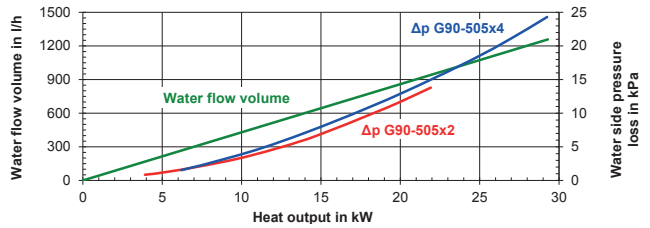

Hot Water Pump Reheater SupraBox 1900 D

Ancillary conditions of the selection diagrams: air entry temperature at coil 12°C, air density 1,2 kg/m³, medium water, spread 20K

Maximum heat output

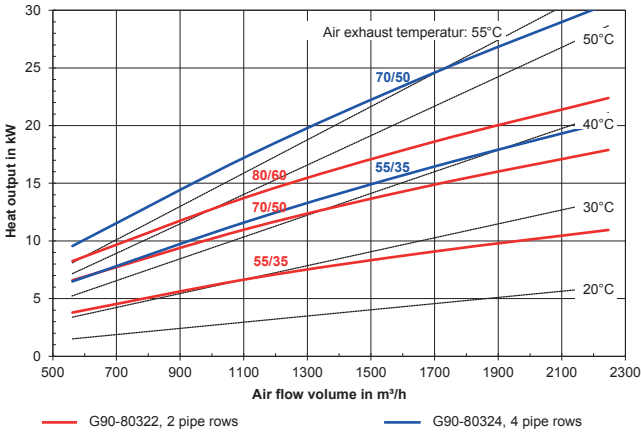

Air side pressure loss

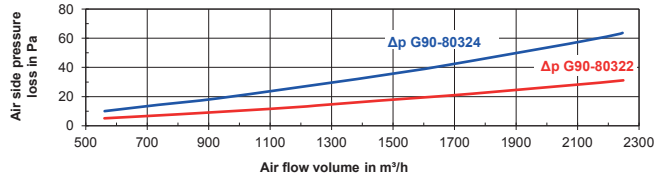

Water flow volume und water side pressure loss (coil)

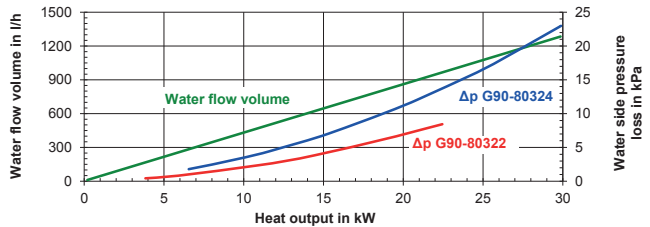

Cold water pump-Cooler SupraBox 800 V / 800 H / 1100 D

Ancillary conditions of the selection diagrams: air entry temperature at coil 27°C, 50% relative humidity, air density 1,2 kg/m³, air pressure 1013,25 hPa, medium water, or rather where noted water with 34% ethylene glycol (down to -20°C), spread 6 K

Maximum Cooling Output

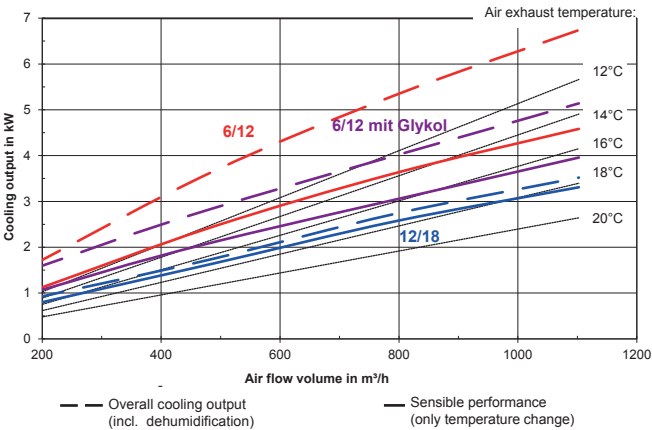

Air side pressure loss

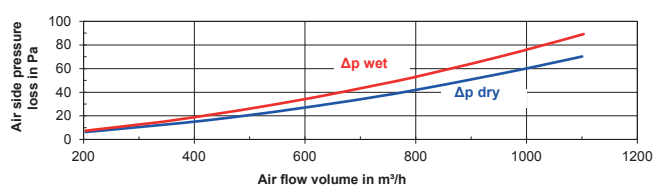

Water flow volume und water side pressure loss

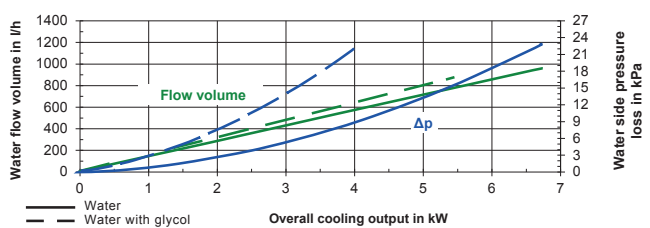

Cold water pump-Cooler SupraBox 1100 V / 1100 H

Ancillary conditions of the selection diagrams: air entry temperature at coil 27°C, 50% relative humidity, air density 1,2 kg/m³, air pressure 1013,25 hPa, medium water, or rather where noted water with 34% ethylene glycol (down to -20°C), spread 6 K

Maximum Cooling Output

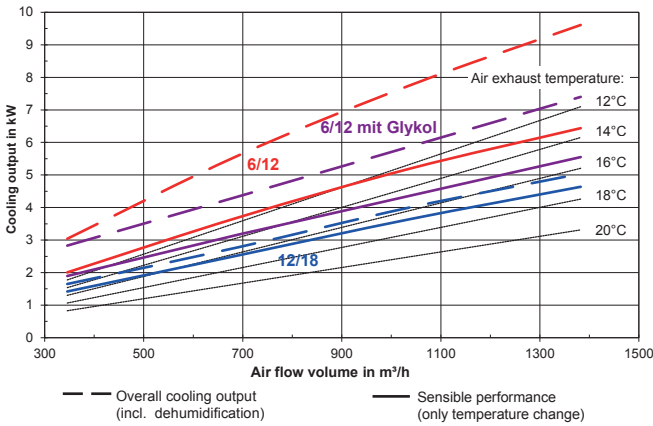

Air side pressure loss

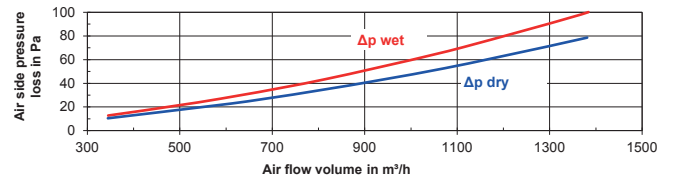

Water flow volume und water side pressure loss

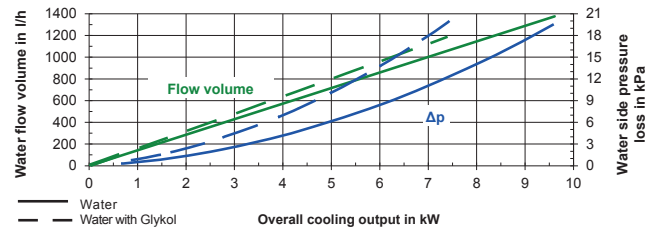

Cold water pump-Cooler SupraBox 1500 V / 1500 H / 2000 V / 2000 H

Ancillary conditions of the selection diagrams: air entry temperature at coil 27°C, 50% relative humidity, air density 1,2 kg/m³, air pressure 1013,25 hPa, medium water, or rather where noted water with 34% ethylene glycol (down to -20°C), spread 6 K

Maximum Cooling Output

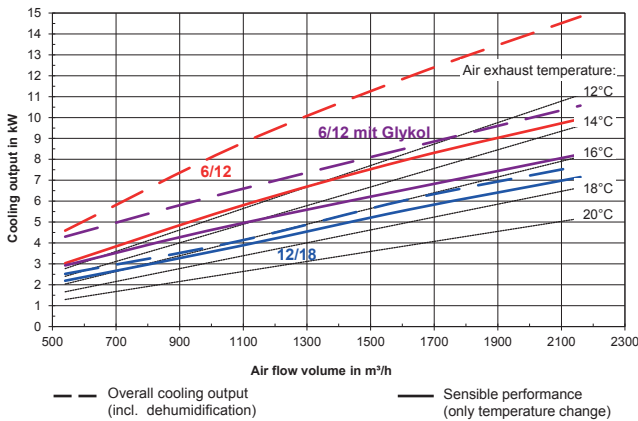

Air side pressure loss

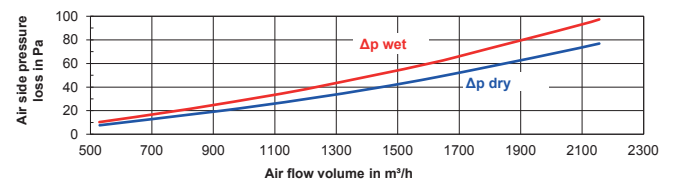

Water flow volume und water side pressure loss

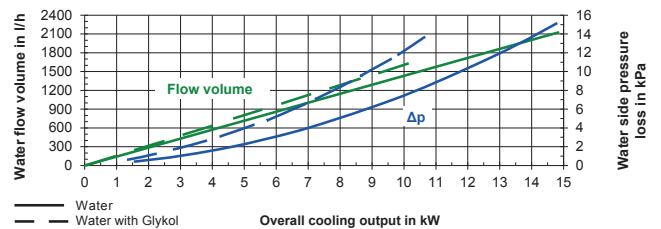

Cold water pump-Cooler SupraBox 1900 D

Ancillary conditions of the selection diagrams: air entry temperature at coil 27°C, 50% relative humidity, air density 1,2 kg/m³, air pressure 1013,25 hPa, medium water, or rather where noted water with 34% ethylene glycol (down to -20°C), spread 6 K

Maximum Cooling Output

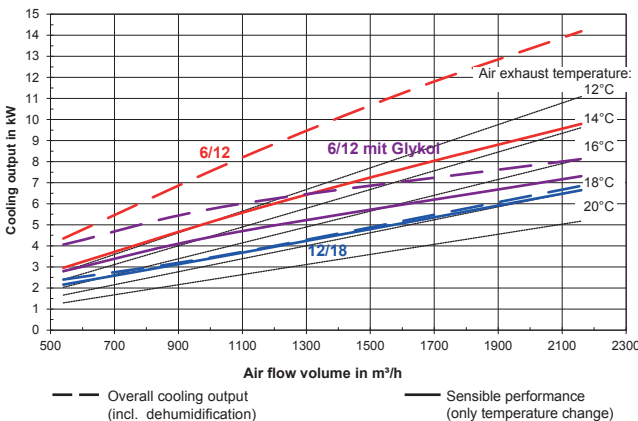

Air side pressure loss

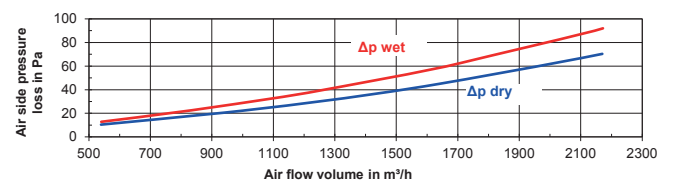

Water flow volume und water side pressure loss

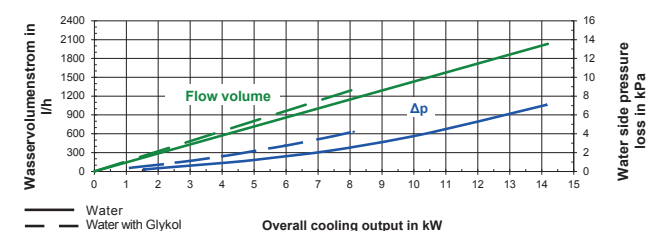

Already included in the scope of delivery of the hot water pump/cold water pump coil are 3-way valves:

- 3-way valve type VRG3 for use as mixing valve
- complies with the pressure device guidelines 97/23/EC
- Valve housing gray cast iron EN-GJL-250 with cylindrical external screw thread after ISO 228/1
- valve rod stainless steel, valve cone copper, valve rod seals EPDM
- suitable for water and water glycol mixtures, 2-120°C, pH 7-10, max. 50% glycol
- valve characteristic logarithmic / linear
- valve setting ratio for cooler SupraBox 1900D min. 100:1, for heater SupraBox 350 min. 30:1, otherwise min. 50:1
- internal leakage with closed valve 0,05% of kVS in flow direction A-AB and max. 1% of kVS in flow direction B-AB



Allocation and Valve Characteristics kVS					
SupraBox	Coil Installation Kit	(Art.-Nr.)	k_{VS} [m³/h]	Connection Valve: Diameter	Connection Valve: External Thread
800 V / 800 H / 1100 D	Hot Water Pump Reheater	G90-353x2	1	DN15	G 1/2"
		G90-353x4	1,6	DN15	G 1/2"
	Cold Water Pump Cooler	G91-353x5	1,6	DN15	G 1/2"
1100 V / 1100 H	Hot Water Pump Reheater	G90-404x2	1,6	DN15	G 1/2"
		G90-404x4			
	Cold Water Pump Cooler	G91-404x6	2,5	DN15	G 1/2"
1500 V / 1500 H / 2000 V / 2000 H	Hot Water Pump Reheater	G90-505x2	2,5	DN15	G 1/2"
		G90-505x4			
	Cold Water Pump Cooler	G91-505x6	4	DN15	G 1/2"
1900 D	Hot Water Pump Reheater	G90-80322	2,5	DN15	G 1/2"
		G90-80324			
	Cold Water Pump Cooler	G90-80326	6,3	DN20	G 3/4"

Valve pressure loss:

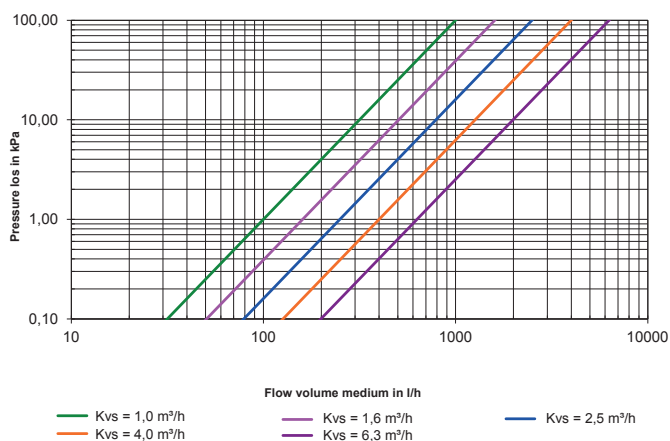

Note:

In each installation kit are the appropriate screw connections with seals for all 3 connections of the valve as well as the actuator. The nominal diameter of the screw connections corresponds to that of the valves.

Brief description of the accessories already included:

Actuator for 3-way-valves

- Type AME 435
- Protection IP54
- Ambient temperature 0 to 55°C
- 24V AC, max. 4,5 VA
- continuous adjustment
- maximum pulling load 400N
- adjustment speed 7,5 s/mm
- easy installation through attachment to the 3-way-valve



Duct temperature sensor

- temperature sensor for measuring the supply air after the coil
- Type EKFC 10/150
- Sensor Type NTC 10K, Resistance 10 kΩ at 25°C
- Protection IP65
- Measurement range -30 to 150°C, Ambient temperature max. 70°C
- Sensor pipe Ø 6mm, V2A (1.4301), Installation length 165 mm
- Sensor is inserted into the duct through the hole Ø 6mm and attached with 2 sheet metal screws in the plastic housing
- Dimensions plastic housing (LxWxH): 64 x 58 x 34 mm



Frost protection thermostat

(only for hot water pumps reheat coils)

- thermostat for activating the frost prevention of the SupraBox control
- Protection of the coil against freezing
- Capillary line directly wrapped on the coil
- Type JTF-5
- Protection IP40
- 1 micro switch as potential free contact
- control range -10 to +12 °C
- switching difference 1 K
- Ambient temperature -10 to + 55 °C
- (Coil with control housing must be mounted in such a way that it is not subjected to temperatures that are smaller than the set scale value)
- Sensor: copper gas-filled
- Dimensions (LxWxH): 105 x 55 x 112 mm



Relative sound spectrum LWA6(Okt) using the example of a SupraBox 2000 H

Nominal operating point: 2000 m³/h
External pressure increase: 250 Pa

Air performance:

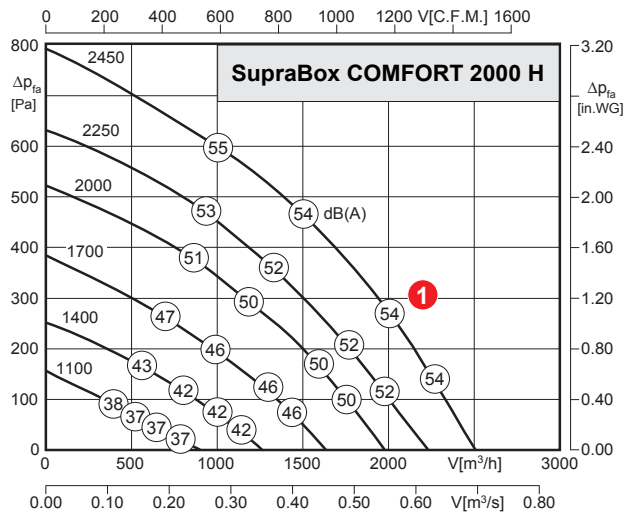

Apparent sound power level:

The sound data represented in the air performance curve is the A-weighted apparent sound power level of the housing L_{WA2} in dB(A).

Pressure side apparent sound power level $L_{WA5} = L_{WA2} + 2$ dB

Discharge side apparent sound power level $L_{WA6} = L_{WA2} + 25$ dB **2**

Calculation:

L_{WA5} per octave: $L_{WA5(Okt)} = L_{WA5} + \text{correction value (table row } L_{WA5})$

L_{WA6} per octave: $L_{WA6(Okt)} = L_{WA6} + \text{correction value (table row } L_{WA6})$

Korrekturwerte: $\Delta L_{W_{Okt}}$ [dB]	fM [Hz]						
	125	250	500	1K	2K	4K	8K
L_{WA5} [dB(A)] Pressure side (Outdoor air / Exhaust air)	-15	-9	-4	-5	-9	-22	-30
L_{WA6} [dB(A)] Discharge side (Supply air / Extract air) 3	-22	-13	-11	-5	-4	-9	-16
L_{WA2} [dB(A)] Noise radiation from the housing	-5	-7	-8	-9	-10	-12	-23

1. Step

Look up L_{WA2} in the air performance diagram **1**
 $= 54$ dB(A)

2. Step

Calculate the pressure side apparent sound power level **2**

$$L_{WA6} = L_{WA2} + 25 \text{ dB} \rightarrow L_{WA6} = 54 \text{ dB(A)} + 25 \text{ dB}$$

$$\rightarrow L_{WA6} = 79 \text{ dB(A)}$$

3. Step

Look up the correction value for L_{WA6} in the table
„Correction Values“ **3**

4. Step

$L_{WA6(Okt)}$ Calculate

Calculation $L_{WA6(Okt)}$	fM [Hz]							Σ
	125	250	500	1K	2K	4K	8K	
L_{WA6} [dB(A)]	79	79	79	79	79	79	79	
+ Correction value [dB]	-22	-13	-11	-5	-4	-9	-16	
Result $L_{WA6(Okt)}$ [dB(A)]	57	66	68	74	75	70	63	79

The overall sound pressure level L_{WA6} must equal 79 dB(A) again through logarithmic addition.